

# ROTARY CAM SWITCHES GF SERIES



 **Lovato**  
**electric**  
ENERGY AND AUTOMATION

**GF20**

GREBENASTE SKLOPKE serije GF pripadaju seriji grebenastih sklopki zaštićenih od slučajnog dodira (svi priključci i kratkospojnice) - DIN/EN 61140. Konstruirane su prema suvremenim principima i dostignućima na području sklopnih aparata uz upotrebu najkvalitetnijih izolacijskih i kontaktnih materijala. Odlikuju se visokim sklopnim moćima, električnom i mehaničkom trajnošću, kao i malim dimenzijama.

Svoju primjenu nalaze u glavnim i pomoćnim strujnim krugovima kao na primjer: motorska sklopka (sklapanje, upravljanje i pokretanje trofaznih i jednofaznih motora) u kategoriji upotrebe AC3, AC23; teretna sklopka (za sklapanje neinduktivnih ili slabo induktivnih tereta) u kategoriji upotrebe AC1 odnosno AC21, te sklopka za upravljačke i mjerne strujne krugove u kategoriji upotrebe AC15.

Sklopke mogu imati najviše 12 upravljačkih položaja, a mogu se izvesti s kutom zakreta od 30°, 45°, 60° i 90°.

Kod sklopki gdje se traži prednji sklop veći od standardnog, sklopke imaju oznaku H (npr. GF20H).

Sklopke GF10 i GF20 mogu se izraditi s pozlaćenim kontaktima.

Grebenaste sklopke serije GF udovoljavaju mnogim internacionalnim i nacionalnim propisima kao što su: **IEC 60947, IEC 60204, DIN EN 61058, UL 508, C22.2 No. 14** itd.

*ROTARY CAM SWITCHES series GF is the series of rotary cam switches protected from inadvertent touch (all connections and possible short circuiting devices) - DIN/EN 61140. They have been designed on modern principles taking into consideration the latest achievements in the field of switching devices and using the best insulation and contact materials. They are distinguished for their high breaking capacity, electrical and mechanical durability and small dimensions.*

*They are used in main and auxiliary circuits such as: motor switch (switching, control and starting of three-phase and single-phase motors) in the utilization categories AC3 and AC23; load break switch (for switching of non-inductive or slightly inductive loads) in the utilization category AC1 or AC21 and cam switch for control and measuring circuits in the utilization category AC15.*

*Rotary cam switches can have maximum 12 control positions, with turning angles of 30°, 45°, 60° and 90°.*

*At the switches where is front part bigger then standard size required, the switches are marked with H (e.g. GF20H).*

*GF10 and GF20 can be supplied with gold-plated contacts.*

*Rotary cam switches series GF comply with many international and national standards such as: IEC 60947, IEC 60204, DIN EN 61058, UL 508, C22.2 No. 14 and many others.*

**GF10**

TIP TYPE	Max. broj elem. Max number of elements	Oblik upravljač. Mount. front	Ugrad. veličina Mounting size	$I_{th}$ , $U_{i-}$
GF10	8	Upravljač/front mount - B	A00 (E30 mm)	10A, 480V
GF20	12	Upravljač/front mount - B Upravljač/back mount - B	A0 (E48 mm)	20A, 480V
GF10H	8	Upravljač/front mount - B	A0 (E48 mm)	10A, 480V
GF20H	12	Upravljač/front mount - B Upravljač/back mount - B	A1 (E66 mm)	20A, 480V
GF20R	5	Upravljač/front mount - B	A00 (E30 mm)	20A, 480V

H - veći prednji sklop od standardnog / bigger front part then standard

R - manji prednji sklop za GF20 (A00) / smaller front part for GF20 (A00)

TIP SKLOPKE SWITCH TYPE		GF10 GF10H	GF20 GF20H GF20R		
Nazivni izolacijski napon Rated insulation voltage	$U_i$	V	480	480	
Nazivni udarni podnosi napon Rated impulse withstand voltage	$U_{imp}$	kV	4	4	
Nazivna termička struja Rated thermal current	$I_t$	A	10	20	
Glavna sklopka / Main switch					
- najveća vrijednost nazivnog pogon. napona - max. value of rated operational voltage		V	400	480	
Nazivna kratkotrajna podt. struja Rated short-time withstand current	$I_{sc}$ 1sec	A	250	250	
Nazivna pogonska struja Rated operational current	$I_n$				
	AC1/AC21A	A	10	20	
	AC15 220/230V 380-480V	A	3	8	
		A	2	6	
Motorska sklopka za kateg. upotrebe:	3 phase AC3	220/230V 380-480V	kW	1,5	3
			kW	2,2	5
Motorska sklopka u kategoriji upotrebe:	3 phase AC23	220/230V 380-480V	kW	1,8	5
			kW	3	7,5
Max. veličina osigurača za zaštitu od kratkog spoja		3A	A	16	20
		5A	A	16	20
Max. fuse size for short circuit protection	(g/g/gL)	10A	A	10	20
		25A	A	-	20
Presjek vodiča Conductor size					
	max. str.	2x	mm <sup>2</sup> AWG	1,5/1,5	2,5/2,5
				14/14	12/12
1 = jednolični / rigid					
1 = višezini / flexible	min. str.	2x	mm <sup>2</sup> AWG	0,5/0,5	0,5/0,5
				20/20	20/20







POSEBNE IZVEDBE *OPTIONAL EXTRAS*

KOD *CODE*

		1	2	3	4		
STANDARDNE SKLOPKE / STANDARD SWITCHES	<p>UGRADINA SKLOPKA</p> <p>FRONT MOUNTING</p> 	<p>Prednji sklop □30 / Front assembly □30</p> <p>Prednji sklop □48 / Front assembly □48</p> <p>Prednji sklop □30 s natpisom / Front assembly □30 with title</p> <p>Prednji sklop □48 s natpisom / Front assembly □48 with title</p> <p>Prednji sklop □65 / Front assembly □65</p>	<p>GF10</p> <p>GF20</p> <p>GF10</p> <p>GF20</p> <p>GF10H</p> <p>GF20H</p>	-	-	U	
	<p>Blokada lijevog smjera okretanja / Interlocking of anticlockwise rotation</p> <p>Zaštita IP65 / Front protection IP65</p> <p>Zaštita IP65 / Front protection IP65</p>	<p>GF20</p> <p>GF10</p> <p>GF20</p>	-	-	U	28	
STANDARDNE SKLOPKE / STANDARD SWITCHES	<p>SKLOPKA ZA ODVJENU UGRADNJU</p> <p>REAR MOUNTING</p> 	<p>Prednji sklop □48 / Front assembly □48</p> <p>Prednji sklop □48 s natpisom / Front assembly □48 with title</p> <p>Prednji sklop □65 / Front assembly □65</p> <p>Prednji sklop □65 s natpisom / Front assembly □65 with title</p>	<p>GF20</p> <p>GF20</p> <p>GF20H</p> <p>GF20H</p>	-	-	0	N
	<p>Blokada lijevog smjera okretanja / Interlocking of anticlockwise rotation</p> <p>Zaštita IP65 / Front protection IP65</p>	<p>GF20</p> <p>GF20</p>	-	-	0	28	
SKLOPKA SA ZAKLJUČAVANJEM LOKOTOM	<p>SKLOPKA SA ZAKLJUČAVANJEM LOKOTOM</p> <p>SWITCH WITH PADLOCK</p> 	<p>Ručica i prednja ploča iste boje</p> <p>The grey colour of handle and front plate</p>	<p>GF10H</p> <p>GF20</p> <p>GF20H</p>	-	-	U	06
	<p>Glavna sklopka - crna ručica i prednja ploča</p> <p>Main switch - black handle and front plate</p>	<p>GF10H</p> <p>GF20</p> <p>GF20H</p>	-	-	U	23	
SKLOPKA SA ZAKLJUČAVANJEM LOKOTOM	<p>SKLOPKA SA ZAKLJUČAVANJEM LOKOTOM</p> <p>SWITCH WITH PADLOCK</p> 	<p>Ručica i prednja ploča iste boje</p> <p>The same colour of handle and front plate</p>	<p>GF10H</p> <p>GF20</p>	-	-	U	56
	<p>Glavna sklopka - crna ručica i prednja ploča</p> <p>Main switch - black handle and front plate</p>	<p>GF10H</p> <p>GF20</p>	-	-	U	73	
SKLOPKA SA ZAKLJUČAVANJEM LOKOTOM	<p>SKLOPKA SA ZAKLJUČAVANJEM LOKOTOM</p> <p>SWITCH WITH PADLOCK</p> 	<p>Glavna sklopka ujedno i sklopka za nužno isklapanje</p> <p>crvena ručica, žuta prednja ploča</p> <p>Main switch with emergency - red handle, yellow front plate</p>	<p>GF10H</p> <p>GF20</p> <p>GF20H</p>	-	-	U	25
	<p>Glavna sklopka ujedno i sklopka za nužno isklapanje</p> <p>crvena ručica, žuta prednja ploča</p> <p>Main switch with emergency - red handle, yellow front plate</p>	<p>GF10H</p> <p>GF20</p>	-	-	U	25	
SPOJKA ZA VRATA / DOOR COUPLING	<p>SPOJKA ZA VRATA</p> <p>DOOR COUPLING</p> 	<p>Otvaranje vrata u bilo kojem položaju / Door opening in any position</p> <p>- montaža s 4 vijka (57) / mounting with 4 screws (57)</p> <p>- montaža s 2 vijka (57D) / mounting with 2 screws (57D)</p>	<p>GF20</p> <p>GF20H</p> <p>GF20</p> <p>GF20H</p>	-	-	0	57
	<p>Otvaranje vrata u položaju "0" / Door opening in position "0"</p> <p>- montaža s 4 vijka (58) / mounting with 4 screws (58)</p> <p>- montaža s 2 vijka (58D) / mounting with 2 screws (58D)</p>	<p>GF20</p> <p>GF20H</p> <p>GF20</p> <p>GF20H</p>	-	-	0	58	
SPOJKA ZA VRATA / DOOR COUPLING	<p>SPOJKA ZA VRATA-GLAVNA SKLOPKA I SKLOPKA ZA NUŽNO ISKLAPANJE</p> <p>DOOR COUPLING-MAIN SWITCH WITH EMERGENCY OFF</p> 	<p>Zaključavanje (1-3) lokota samo u "0" - otvaranje vrata u položaju "0"</p> <p>Padlocking (1-3) only in "0" - door opening in position "0"</p>	<p>GF20</p> <p>GF20H</p>	-	-	0	98
	<p>Zaključavanje (1-3) lokota samo u "0" - otvaranje vrata u polož. "0"</p> <p>Padlocking (1-3) only in "0" - door opening in position "0"</p>	<p>GF20</p> <p>GF20H</p>	-	-	0	98	
SPOJKA ZA VRATA / DOOR COUPLING	<p>SPOJKA ZA VRATA-ZAKLJUČAVANJE LOKOTOM</p> <p>DOOR COUPLING-SWITCH WITH PADLOCK</p> 	<p>Ručica i prednja ploča iste boje</p> <p>The same colour of handle and front plate</p>	<p>GF20</p>	-	-	0	85
	<p>Glavna sklopka ujedno i sklopka za nužno isklapanje</p> <p>crvena ručica, žuta prednja ploča</p> <p>Main switch with emergency - red handle, yellow front plate</p>	<p>GF20</p>	-	-	0	86	

POSEBNE IZVEDBE *OPTIONAL EXTRAS*

 KOD *CODE*

		1	2	3	4
SKLOPKE SA ZAKLJUČAVANJEM SWITCHES WITH LOCKING	 <p>Standardno zaključavanje u "0" - moguće i u drugim položajima (potrebno definirati). Vađenje ključa samo u zaključanom položaju.</p> <p><i>In standard manner locking is in "0" - possible in other positions, too please define! The key can be pulled out only in locked position.</i></p>	GF20H	-	-	U 05
BLOKIRANJE POLOŽAJA-DVOROČNO UPRAVLJANJE BLOCKADE OF POSITIONS-TWO HANDS OPERATING	 <p>Zaštita od nehoćnog uklapanja, blokada moguća u svim položajima (potrebno definirati)</p> <p><i>Protection against an accidental switching-on, blockade is possible in any position (please define)</i></p> <ul style="list-style-type: none"> <li>• bez zaključavanja i pom. kontakata (16) / <i>without locking and aux. contacts (16)</i></li> <li>• zaključavanje jednim lokotom (26) / <i>locking by one padlock (26)</i></li> <li>• jedan par pom. kontakata 1NO+1NC (17) / <i>one pair of aux. contacts 1NO+1NC (17)</i></li> <li>• zaključavanje jednim lokotom i jedan par pom. kontakata 1NO+1NC (27) / <i>locking by one padlock and one pair of aux. contacts 1NO+1NC (27)</i></li> </ul>	GF20H	-	-	U 16
		GF20H	-	-	U 26
		GF20H	-	-	U 17
		GF20H	-	-	U 27
SKLOPKA S PRODUŽENOM OSOVINOM SWITCH WITH EXTENDED SHAFT	 <p>Standardna izvedba podrazumijeva produženje 100 mm. Specijalnom narudžbom potrebno je definirati dubinu omara.</p> <p><i>Standard version includes the extension for 100 mm. Otherwise is necessary to define board depth.</i></p>	GF20	-	-	0 02
		GF20H	-	-	0 02
PRODUŽENJE OSOVINE I SPOJKA ZA VRATA EXTENSION SHAFT AND DOOR COUPLING	 <p>Otvaranje vrata u položaju "0" / <i>Door opening in position "0"</i></p> <ul style="list-style-type: none"> <li>• osovina 100 mm (102) / <i>shaft 100 mm (102)</i></li> <li>• osovina 200 mm (102-200) / <i>shaft 200 mm (102-200)</i></li> </ul>	GF20	-	-	0 102
		GF20H	-	-	0 102
PRODUŽENJE OSOVINE I SPOJKA ZA VRATA EXTENSION SHAFT AND DOOR COUPLING	 <p>Otvaranje vrata u položaju "0", standardno s jednim modulom</p> <p><i>Door opening in position "0", standard version with one module</i></p> <ul style="list-style-type: none"> <li>• dva modula (108D-2) / <i>two modules (108D-2)</i></li> <li>• tri modula (108D-3) / <i>three modules (108D-3)</i></li> <li>• četiri modula (108D-4) / <i>four modules (108D-4)</i></li> </ul>	GF20	-	-	U 108D
		GF20H	-	-	U 108D
SKLOPKA ZA NUŽNO ISKLAPANJE EMERGENCY OFF SWITCH	 <p>Sklopka sa žutom prednjom pločom, žutom podlogom i crvenom ručicom</p> <p><i>Switch with yellow front plate, yellow escutcheon plate and red handle</i></p>	GF10	-	-	U 24
		GF10H	-	-	U 24
		GF20	-	-	W/D 24
		GF20H	-	-	W/D 24
SMANJENJE PREDNJEG SKLOPA SMALLER FRONT PART	 <p>Prednji sklop veličine □30 / <i>Front part size □30</i></p> <p>Prednji sklop veličine □30 s natpisom / <i>Front part size □30 with title</i></p> <p>Zaštita IP65 / <i>Front protection IP65</i></p>	GF20R	-	-	U
		GF20R	-	-	U N
		GF20R	-	-	U 51

POSEBNE IZVEDBE *OPTIONAL EXTRAS*

KOD *CODE*

			1	2	3	4
<p>MONTAŽA NA ŠINU</p> <p>MOUNTING ON THE RAIL</p>		<p>Montaža na šinu 35 EN 50022</p> <p>Mounting on the rail 35 EN 50022</p>	GF20	- ... -	U/O	18
		<p>GF20H</p> <p>- ... -</p> <p>U/O</p> <p>18</p>				
<p>SIGNALNE SVJETILJKE</p> <p>SIGNAL LAMPS</p>		<p>Standardno ugrađena crvena svjetiljka (230V) dole desno. Mogući naponi 110V, 400V kao i zelena boja svjetiljke (potrebno definirati).</p> <p>In a standard manner, the red lamp (230V) is built in the right bottom corner. Possible voltages are 110V, 400V and green lamp, too (please define).</p>	GF10H	- ... -	U	15
		<p>GF20</p> <p>- ... -</p> <p>U/O</p> <p>15</p>				
		<p>GF20H</p> <p>- ... -</p> <p>U/O</p> <p>15</p>				
<p>INSTALACIONA KAPA</p> <p>SERVICE COVER</p>		<p>Montaža na šinu 35 EN 50022 s visinskim podešavanjem instalacione kape (45 mm) i ručice za 7 mm</p> <p>Snap on base mounting for the rail 35 EN 50022. Both the service cover (45 mm) and handle are adjustable in height (7 mm).</p>	GF20	- ... -	0	48
		<p>Fiksna ugrađena dužina (480)</p> <p>Fixed measure (480)</p>	GF20	- ... -	0	480
<p>INSTALACIONA KAPA</p> <p>SERVICE COVER</p>		<p>Montaža na šinu 35 EN 50022 s visinskim podešavanjem instalacione kape (45 mm) i bravice za 7 mm</p> <p>Snap on base mounting for the rail 35 EN 50022. Both the service cover (45 mm) and key are adjustable in height (7 mm).</p>	GF20	- ... -	0	49
<p>SKLOPKA S RUČICOM I MATICOM</p> <p>ROTARY CAM SWITCH WITH HANDLE AND NUT</p>		<p>Montaža u <math>\varnothing 30</math> mm / Mounting in <math>\varnothing 30</math> mm</p>	GF20	- ... -	U	09
		<p>Montaža u <math>\varnothing 22</math> mm / Mounting in <math>\varnothing 22</math> mm</p>	GF20	- ... -	U	11
		<p>Zaključavanje odnosedno vadenje ključa pod 90°</p> <p>Locking and pull-out of the key at 90°</p>				
<p>SKLOPKA S KLJUČEM I MATICOM</p> <p>ROTARY CAM SWITCH WITH KEY AND NUT</p>		<p>Montaža u <math>\varnothing 30</math> mm / Mounting in <math>\varnothing 30</math> mm</p>	GF20	- ... -	U	10
		<p>Montaža u <math>\varnothing 22</math> mm / Mounting in <math>\varnothing 22</math> mm</p>	GF20	- ... -	U	12
		<p>Zaključavanje odnosedno vadenje ključa pod 90°</p> <p>Locking and pull-out of the key at 90°</p>				
<p>SKLOPKA S RUČICOM I PREDNJOM PLOČOM <math>\square 48</math></p> <p>ROTARY CAM SWITCH WITH HANDLE AND FRONT PLATE <math>\square 48</math></p>		<p>Montaža u <math>\varnothing 22</math> odnosno <math>\varnothing 30</math> mm. Montaža s dva vijka.</p> <p>Mounting into <math>\varnothing 22</math> or <math>\varnothing 30</math> mm with two screws</p>	GF20	- ... -	U	20

POSEBNE IZVEDBE *OPTIONAL EXTRAS*

 KOD *CODE*

		1	2	3	4		
CENTRALNA MONTAŽA <i>CENTRAL MOUNTING</i>	SKLOPKA SA ZAKLJUČAVANJEM <i>ROTARY CAM SWITCH WITH LOCKING</i> 	Utična montaža kontaktnog bloka i prednjeg sklopa <i>Snap-on mounting of contact block with front part</i>					
		Brza montaža u $\varnothing 22$ mm, sklopka s prednjom pločom, ručica za zaključavanje / <i>Quick mounting into <math>\varnothing 22</math> mm, switch with front plate, lockable handle</i>	GF20	-	-	U	41D
		Brza montaža u $\varnothing 22$ mm, ručica za zaključavanje, sklopka bez prednje ploče / <i>Quick mounting into <math>\varnothing 22</math> mm, lockable handle, switch without front plate</i>	GF20	-	-	U	41K
CENTRALNA MONTAŽA <i>CENTRAL MOUNTING</i>	SKLOPKA S RUČICOM I PREDNJOM PLOČOM <i>ROTARY CAM SWITCH WITH HANDLE AND FRONT PLATE</i> 	Utična montaža kontaktnog bloka i prednjeg sklopa <i>Snap-on mounting of contact block with front part</i>					
		Brza montaža u $\varnothing 16$ mm / <i>Quick mounting in <math>\varnothing 16</math> mm</i>	GF10	-	-	U	46
		Brza montaža u $\varnothing 22$ mm / <i>Quick mounting in <math>\varnothing 22</math> mm</i>	GF10	-	-	U	47
			GF20	-	-	U	47
CENTRALNA MONTAŽA <i>CENTRAL MOUNTING</i>	SKLOPKA BEZ PREDNJE PLOČE <i>ROTARY CAM SWITCH WITHOUT FRONT PLATE</i> 	Utična montaža kontaktnog bloka i prednjeg sklopa <i>Snap-on mounting of contact block with front part</i>					
		Brza montaža u $\varnothing 16$ mm / <i>Quick mounting in <math>\varnothing 16</math> mm</i>	GF10	-	-	U	66
		Brza montaža u $\varnothing 22$ mm / <i>Quick mounting in <math>\varnothing 22</math> mm</i>	GF10	-	-	U	67
			GF20	-	-	U	67
CENTRALNA MONTAŽA <i>CENTRAL MOUNTING</i>	PUSH AND TURN 	Zaključavanje (1-3 lokota) in "0" / <i>Padlocking (1-3) in "0"</i>					
		Brza montaža u $\varnothing 22$ mm / <i>Quick mounting in <math>\varnothing 22</math> mm</i>	GF20	-	-	U	71
		Brza montaža u $\varnothing 30$ mm / <i>Quick mounting in <math>\varnothing 30</math> mm</i>	GF20	-	-	U	72
CENTRALNA MONTAŽA <i>CENTRAL MOUNTING</i>	SKLOPKA S KLJUČEM <i>ROTARY CAM SWITCH WITH KEY</i> 	Utična montaža kontaktnog bloka i prednjeg sklopa <i>Snap-on mounting of contact block with front part</i>					
		Brza montaža u $\varnothing 22$ mm, sklopka s prednjom pločom <i>Quick mounting in <math>\varnothing 22</math> mm, switch with front plate</i>	GF20	-	-	U	29D
		Brza montaža u $\varnothing 22$ mm, sklopka bez prednje ploče <i>Quick mounting in <math>\varnothing 22</math> mm, switch without front plate</i>	GF20	-	-	U	29K
NESTANDARNA MONTAŽA <i>NON-STANDARD MOUNTING</i>		Montaža s dva vijka (razmak 28 mm) <i>Mounting with two screws (distance 28 mm)</i>	GF20	-	-	U	39D
			GF20H	-	-	U	39D
		Montaža s dva vijka (razmak 30 mm) <i>Mounting with two screws (distance 30 mm)</i>	GF20	-	-	U	39T
NESTANDARNA MONTAŽA <i>NON-STANDARD MOUNTING</i>		Montaža s 4 umetnute matice M4 <i>Mounting with four inserted nuts M4</i>	GF20	-	-	U	31
			GF20H	-	-	U	31

## NARUDŽBENI KOD *ORDERING CODE*

Prilikom naručivanja sklopke potrebno je definirati:

- za **standardnu izvedbu** sklopke 3 tipa podataka **1 2 3**
- za sklopke s **posebnom izvedbom** maksimalno 5 tipova podataka **1 2 3 4 5**
- za sklopku sa **specijalnim zahtjevima** maksimalno 6 tipova podataka **1 2 3 4 5 Y**

When ordering please define:

- for **standard** switch three data types **1 2 3**
- for switch with an **optional extra** max. 5 data types **1 2 3 4 5**
- for switch with **special requests** max. 6 data types **1 2 3 4 5 Y**

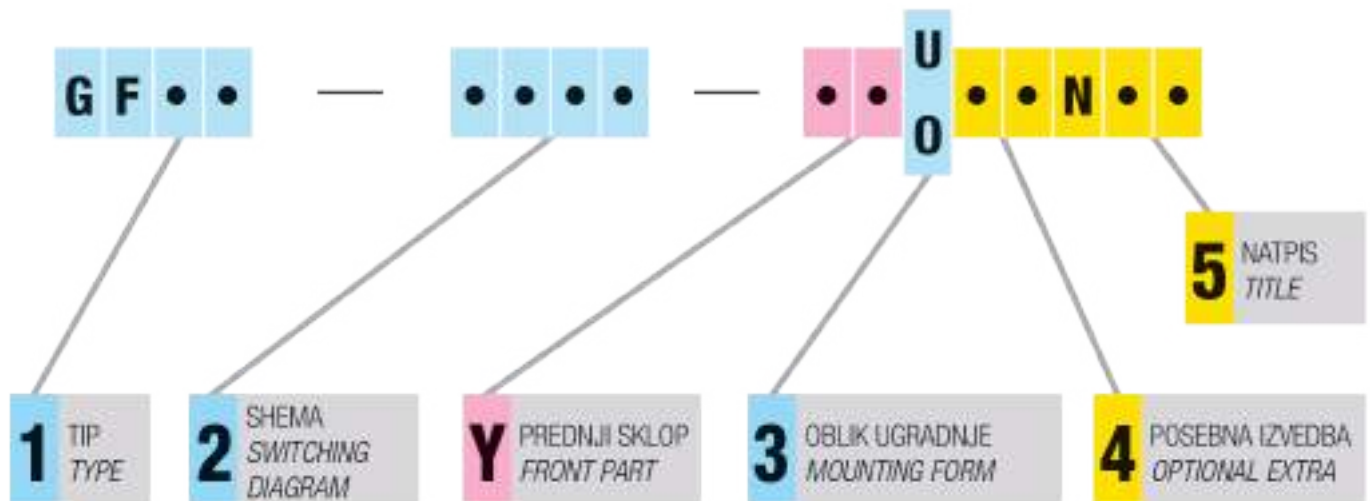

### OPIS

### DESCRIPTION

<b>1</b>	Tip sklopke. Odabire se prema tehničkim zahtjevima i ugradnoj veličini (vidi str. 1)	Switch type. To be chosen in accordance with the technical requests and mounting size (see page 1)
<b>2</b>	Shema. Odabire se prema programu sklapanja (vidi katalog shema)	Switching diagram. To be chosen in accordance with the switching programme (see catalogue with scheme).
<b>Y</b>	Prednji sklop. Upisuje se samo ako se traži nestandardna kombinacija boja i oblika prednjeg sklopa. Kod standardne izvedbe ručica, prednja ploča i slova na bijeloj podlozi su crni.	Front part. To be marked only when non-standard front part colour and form combination is required. For standard form (handle, front plate and text on the white escutcheon plate are black).
<b>3</b>	Standardni oblici ugradnje U, O (vidi str. 2)	Standard mounting forms U, O (see page 2)
<b>4</b>	Posebna izvedba (vidi str. 2, 3, 4 i 5)	To be marked when an optional extra is required (see pages 2, 3, 4 and 5).
<b>5</b>	"N" se upisuje ako se traži prednja ploča s natpisom. Potrebno je upisati željeni tekst.	"N" is to be written when the front plate with a title is required. Please define required text.



Pridržavamo pravo promjene podataka. Ostale podatke dajemo na upit.  
We keep the right to change the data. Other data are given on request.

MJERNE SKICE *DIMENSIONAL DRAWINGS* (mm)

**GF10** Ugradna sklopka / *Front mounting (A)*

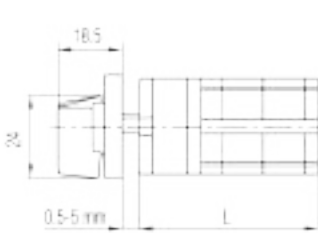

**GF20** Ugradna sklopka / *Front mounting (A)*  
Sklopka za odvojenu ugradnju / *Rear mounting (B)*

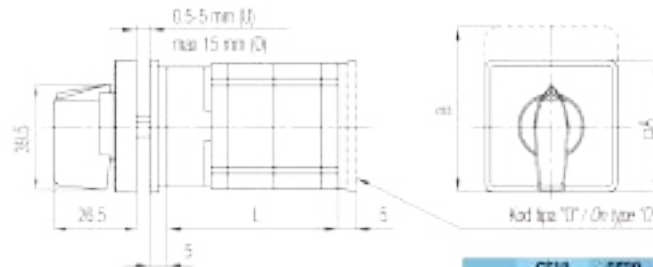

	GF10	GF20
A	30	48
B	40	60



**GF10H** Ugradna sklopka / *Front mounting (A)*

**GF20H** Ugradna sklopka / *Front mounting (A)*  
Sklopka za odvojenu ugradnju / *Rear mounting (B)*

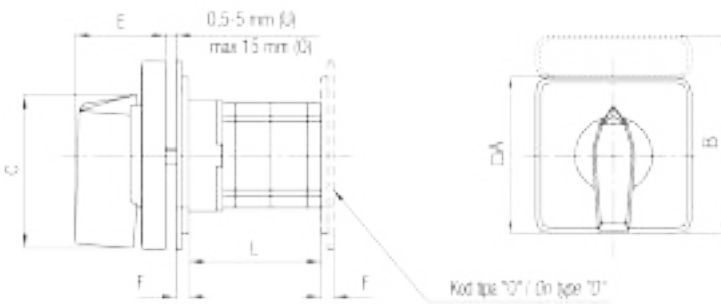

OZNAKA MARKING	TIP SKLOPKE TYPE	
	GF10H	GF20H
A	48	60
B	60	60
C	38.5	50
E	26.5	34.5
F	...	5.5 5.5
TIP UGRADNJE MOUNTING FORM		

**GF20R** Ugradna sklopka / *Front mounting (A)*

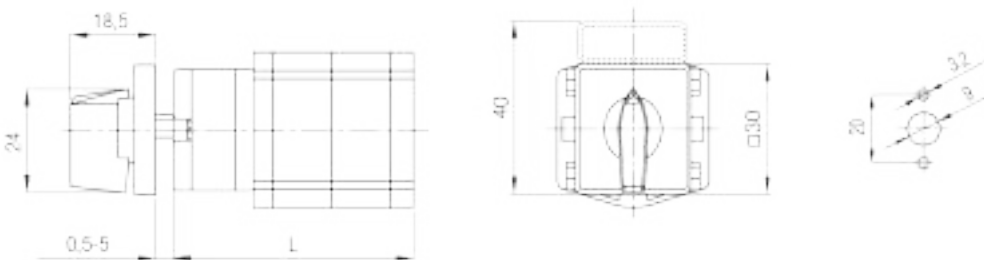

Posebne izvedbe *Optional extras*

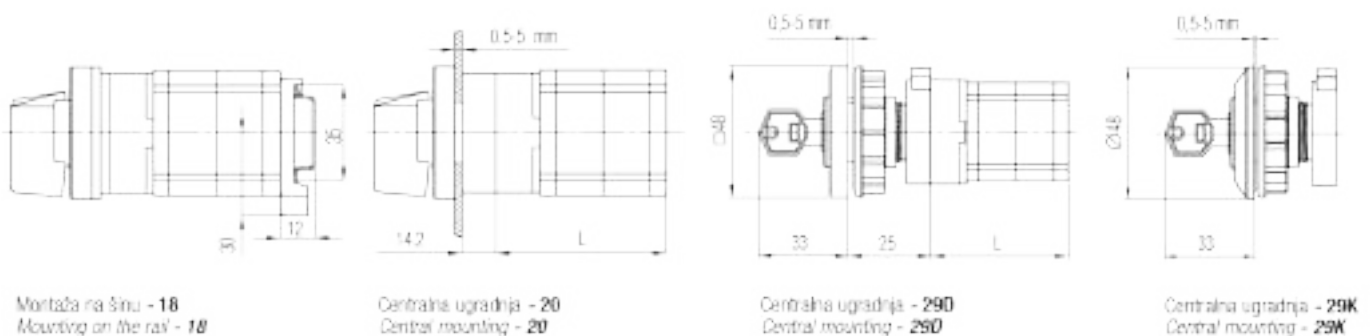

Montaža na šinu - **18**  
*Mounting on the rail - 18*

Centralna ugradnja - **20**  
*Central mounting - 20*

Centralna ugradnja - **290**  
*Central mounting - 290*

Centralna ugradnja - **29K**  
*Central mounting - 29K*



# MJERNE SKICE *DIMENSIONAL DRAWINGS* (mm)

## Posebne izvedbe *Optional extras*

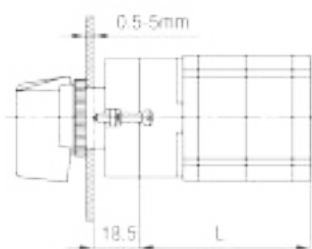

Centralna ugradnja - **09/11**  
Central mounting - **09/11**

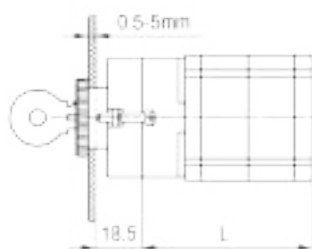

Centralna ugradnja - **10/12**  
Central mounting - **10/12**



Tip/Type	ØD
09, 10, 20	30.5
11, 12, 20, 290, 29K	22.5

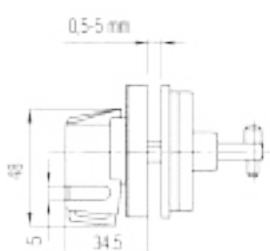

Spojka za vrata -  
zaključavanje lokotom - **85**  
Door coupling -  
padlock - **85**

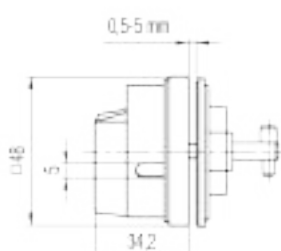

Spojka za vrata -  
zaključavanje lokotom - **90**  
Door coupling -  
padlock - **90**

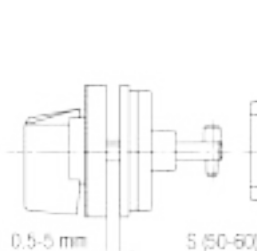

Spojka za vrata - **57/58**  
Door coupling - **57/58**

Ukoliko je traženi "S" veći od standardnog, potrebno je definirati dubinu omara "S+L+F"  
When required "S" is bigger than offered, it is necessary to define the depth of the board "S+L+F"

oznaka MARKING	GF20	GF20H
□K	36	48
F	5	0.5

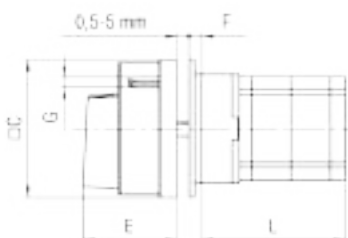

oznaka MARKING	GF10H GF20	GF20H
□G	48	80
E	34.2	34
S	5	6
F	5 GF20	5H

Sklopka sa zaključavanjem lokotom - **06/23/25**  
Switch with padlock - **06/23/25**

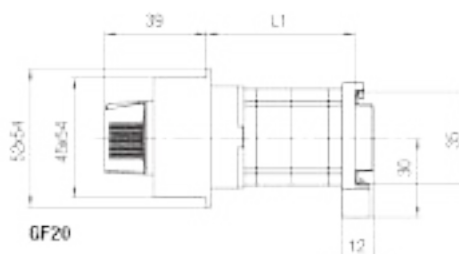

	1 el. 48	2 el. 49-50	3 el. 52-53	3 el. 55-53
L1	48	49	50.5	67

Instalaciona kapa - **48/48D**  
Service cover - **48/48D**

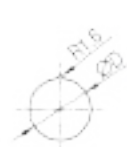
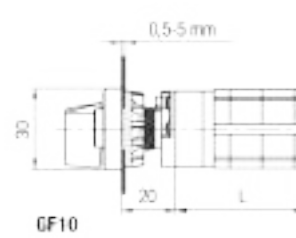

POSREDA IZVEDBA OPTIONAL EXTRA	ØD
46, 66	18
47, 67	27

Centralna montaža - **46/47 i 66/67**  
Central mounting - **46/47 and 66/67**

Broj elemenata No. of elements	1	2	3	4	5	6	7	8	9	10	11	12	
L (mm)	GF10	40	52	64	76	88	100	112	124	-	-	-	
	GF20	36	49,5	63	76,5	90	103,5	117	130,5	144	157,5	171	184,5
	GF10H	40	52	64	76	88	100	112	124	-	-	-	
	GF20H	36	49,5	63	76,5	90	103,5	117	130,5	144	157,5	171	184,5
	GF20R	41,5	53,5	67	80,5	94	107,5	-	-	-	-	-	-

# ■ ROTARY CAM SWITCHES GF SERIES



[www.LovatoElectric.hr](http://www.LovatoElectric.hr)

**LOVATO ELECTRIC d.o.o.**  
Borongajska cesta 81 b  
10002 ZAGREB  
HRVATSKA  
Tel +385 (0)1 2369 243, 2369 203  
[prodaja@LovatoElectric.hr](mailto:prodaja@LovatoElectric.hr)  
[www.LovatoElectric.hr](http://www.LovatoElectric.hr)



Follow us

The products described in this document are subject to updates or modifications at any time. The descriptions, technical and functional information, illustrations and instructions in the leaflet are to be considered as purely illustrative, and consequently have no contractual relevance. Remember also that the products themselves must be used by qualified personnel, in compliance with current plant engineering and installation standards, in order to avoid injury to persons or damage to property.