

# KONČAR

- Ugradna sklopka  
- Front mounting

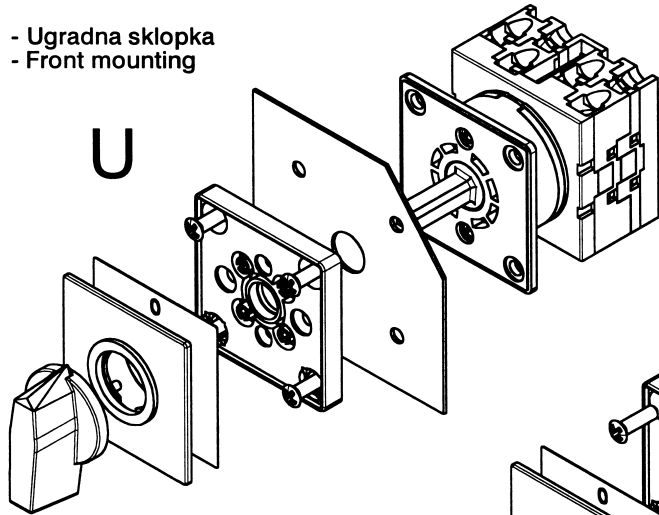

- Odvojena ugradnja  
- Rear mounting

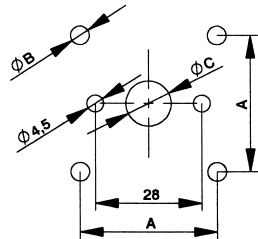
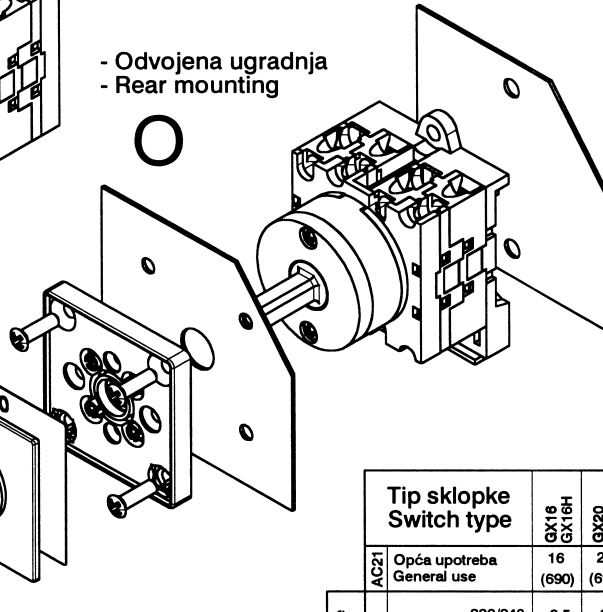

Sklopke Switches	□	Ø B	Ø C	D
	GX16 GX20	36	5	12
GX16H GX20H	48	5,5	12	52
GX32 GX40	48	5,5	14	68
GX32H GX40H	68	7,5	14	68

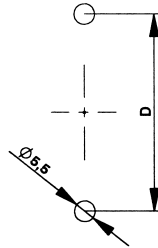

		Tip sklopke Switch type				
		AC21	GX18 GX16H	GX20 GX20H	GX32 GX32H	GX40 GX40H
Opća uporaba General use		16 (690)	20 (690)	32 (690)	40 (690)	
Motorska sklopka za kategoriju uporabe Motor switch in utilization category	3 Faze 3 Phasen	220/240 380/440 500/690	3,5 4,5 5,5	3,7 5,5 5,5	7,5 11 11	7,5 15 15
	1 Faza 1 Phase	110 220/230 380/440	0,75 1,5 2,2	0,75 1,8 3	1,8 3,5 5,5	2,2 4,4 7
	2 Pola 2 Pole					
AC3 (kW)	3 Faze 3 Phase	220/240 380/440 500/690	3,7 6,5 7,5	4 7,5 7,5	8 15 15	9 18,5 15
	1 Faza 1 Phase					
	2 Pola 2 Pole					
AC23 (kW)	1 Faza 1 Phase	110 220/230 380/440	0,75 1,8 3	0,75 2,2 3,5	2,2 3,5 6	3 5,2 7,5
	2 Pola 2 Pole					
	3 Faze 3 Phasen					

Suitable for Use on Circuits Capable of Delivering not more than 5000 rms Symmetrical Amperes, 600 V ac Maximum, when protected by RK 5 Class Fuses rated \*\* A max.  
 \*\* A: For GX16 and GX20  
 \*\* B: For GX32 and GX40



Cat. No.  
 For GX16 and GX20  
 IZPA For GX32 and GX40

"Use fuses Only"

Minimum enclosure size: 125 mm x 185 mm x 118 mm (W x H x D)



AMPERMETARSKE SKLOPKE / AMMETER SWITCHES

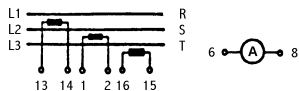

58

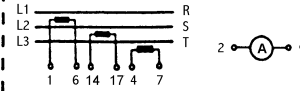

97

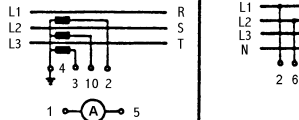

98

VOLTMETARSKO - AMPERMETARSKE SKLOPKE  
VOLTMETER - AMMETER SWITCHES

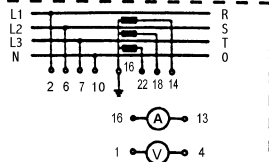

61

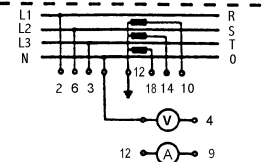

64

VOLTMETARSKE SKLOPKE / VOLTMETER SWITCHES

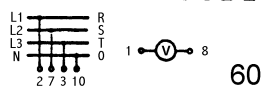

60

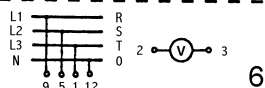

66

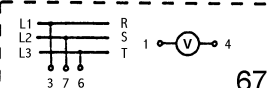

67

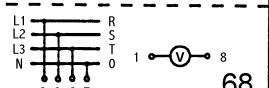

68

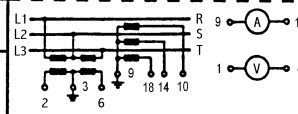

65

SKLOPKE SA POVRATOM - KUT ZAKRETA 30°  
SWITCHES SPRING RETURN WITH 30° SWITCHING

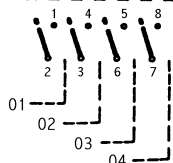

01

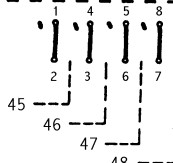

45

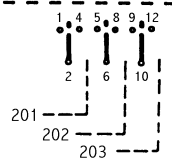

201

SKLOPKE ZA POKRETANJE JEDNOFAZNIH MOTORA  
START AND RUN SWITCHES

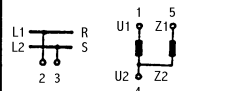

15

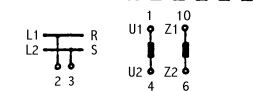

16

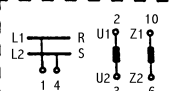

17

UPRAVLJAČKE SKLOPKE SA POVRATOM / CONTROL SWITCHES (WITH SPRING RETURN)

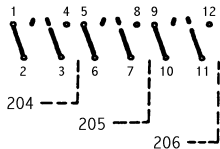

204

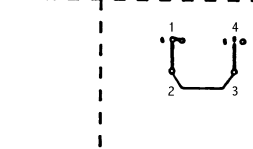

207

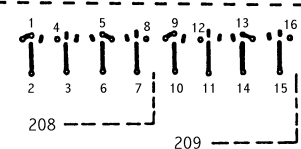

208

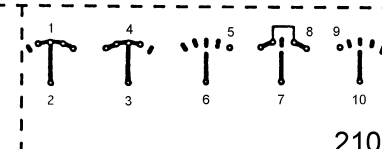

210

MOTORSKE REVERZIJNE SKLOPKE / MOTOR REVERSING SWITCHES

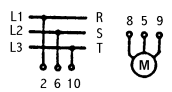

11

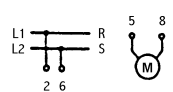

14

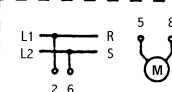

24

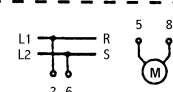

25

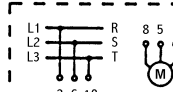

26

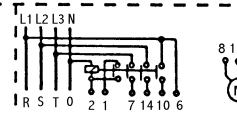

27

### ZVIJEZDA - TROKUT SKLOPKE / STAR - DELTA SWITCHES

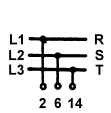

12

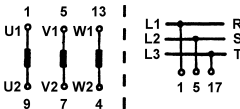

21

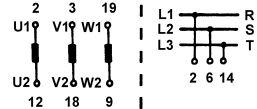

28

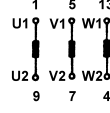

29

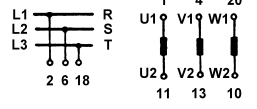

31

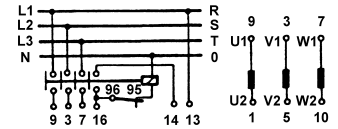

### SKLOPKE ZA UPRAVLJANJE MOTORIMA (ODVOJENI NAMOTI) MOTOR CONTROL SWITCHES (SEPARATE WINDINGS)

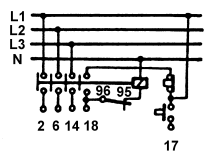

49

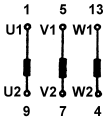

22

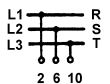

23

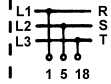

33

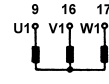

### SKLOPKE ZA UPRAVLJANJE MOTORIMA (DAHLANDER) / MOTOR CONTROL SWITCHES (DAHLANDER)

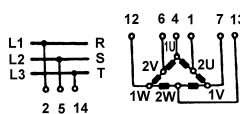

13

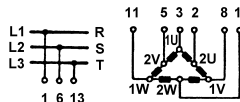

19

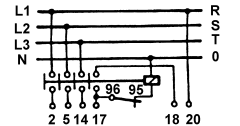

32

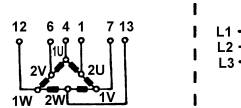

20

### SKLOPKE ZA UPRAVLJANJE TROBRZINSKIM MOTORIMA / SWITCHES FOR 3-SPEED MOTOR CONTROL

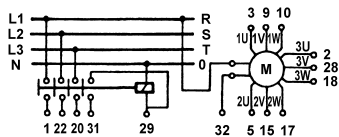

18

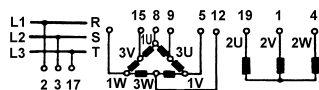

34

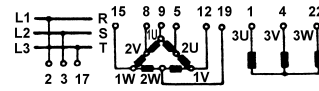

35

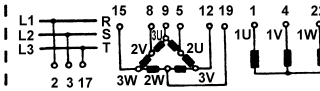

36

**SKLOPKE SA KUTEM ZAKRETA 60°  
SWITCHES WITH 60° SWITCHING**

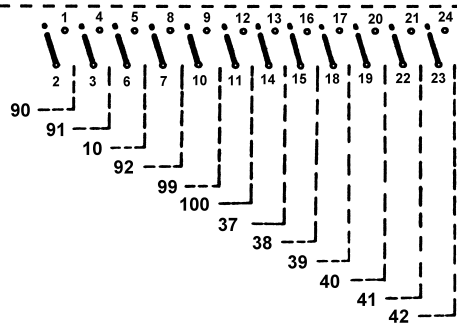

**PREKLOPKE SA "0" POLOŽAJEM SA  
KUTEM ZAKRETA 60°  
CHANGEOVER SWITCHES WITH "0" 60° SWITCHING**

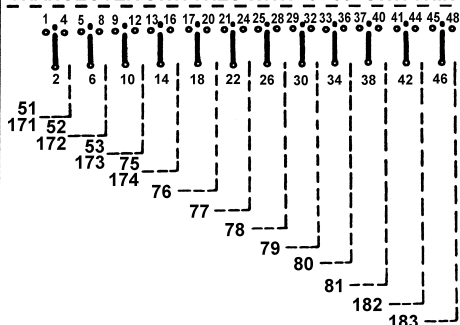

**PREKLOPKE BEZ "0" POLOŽAJA SA  
KUTEM ZAKRETA 90°  
CHANGEOVER SWITCHES WITHOUT "0" 90° SWITCHING**

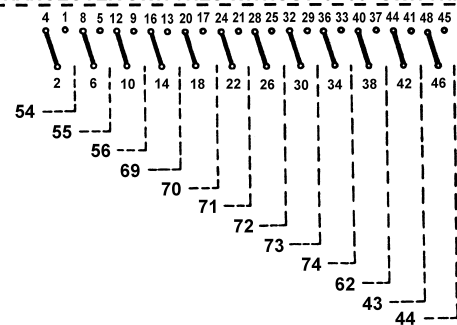

**SKLOPKE SA KUTOM ZAKRETA 90°/ SWITCHES WITH 90° SWITCHING**

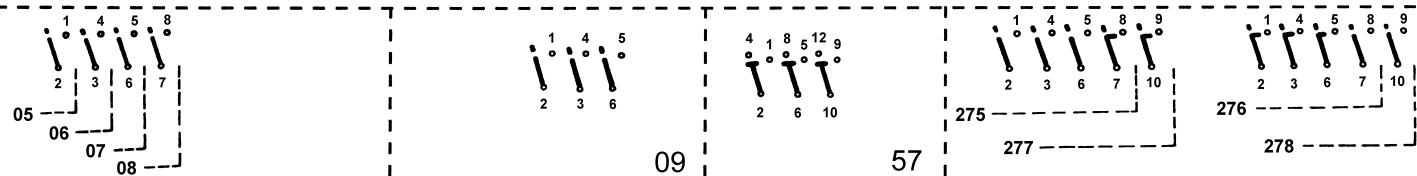

**STEPENASTE SKLOPKE BEZ "0" POLOŽAJA / MULTI-STEP SWITCHES WITHOUT "0"**

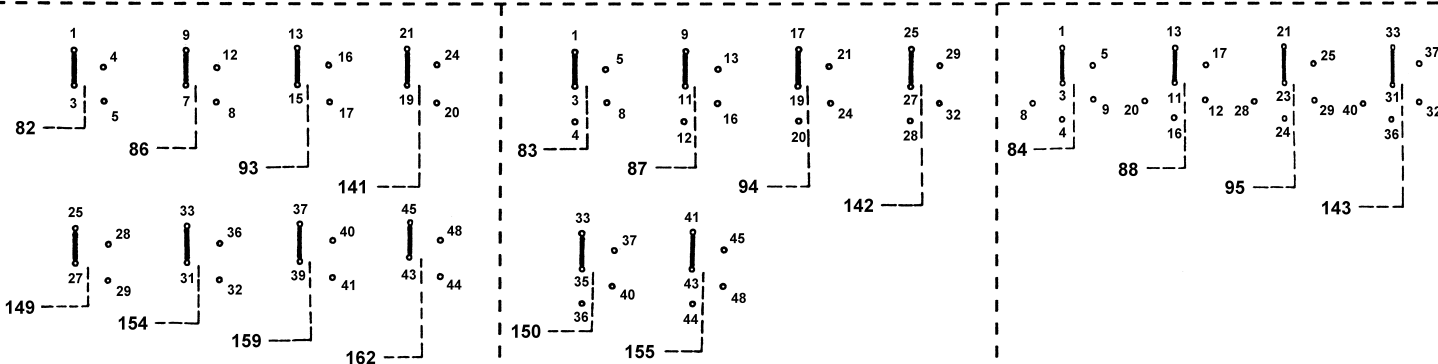

## STEPENASTE SKLOPKE BEZ "0" POLOŽAJA / MULTI-STEP SWITCHES WITHOUT "0"

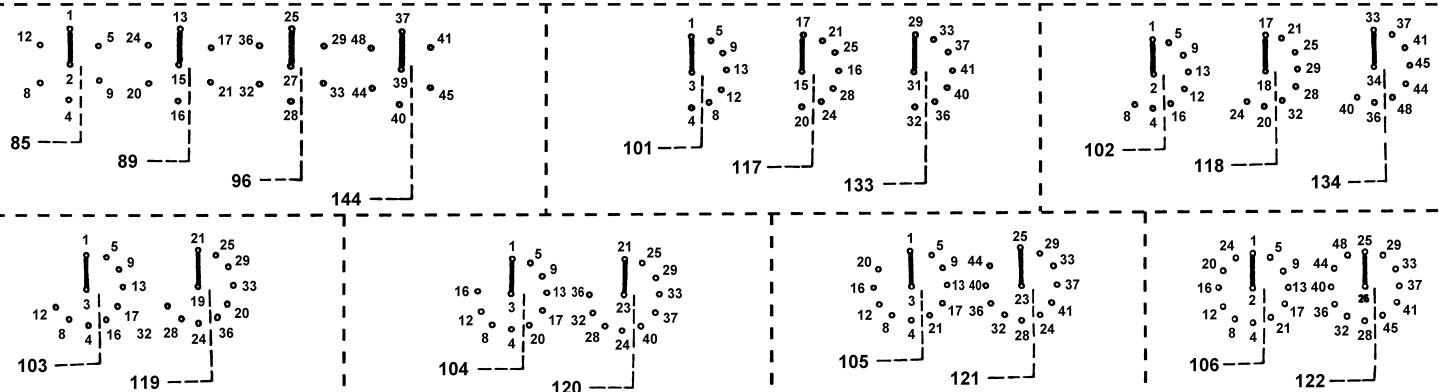

## STEPENASTE SKLOPKE SA "0" POLOŽAJEM / MULTI-STEP SWITCHES WITH "0"

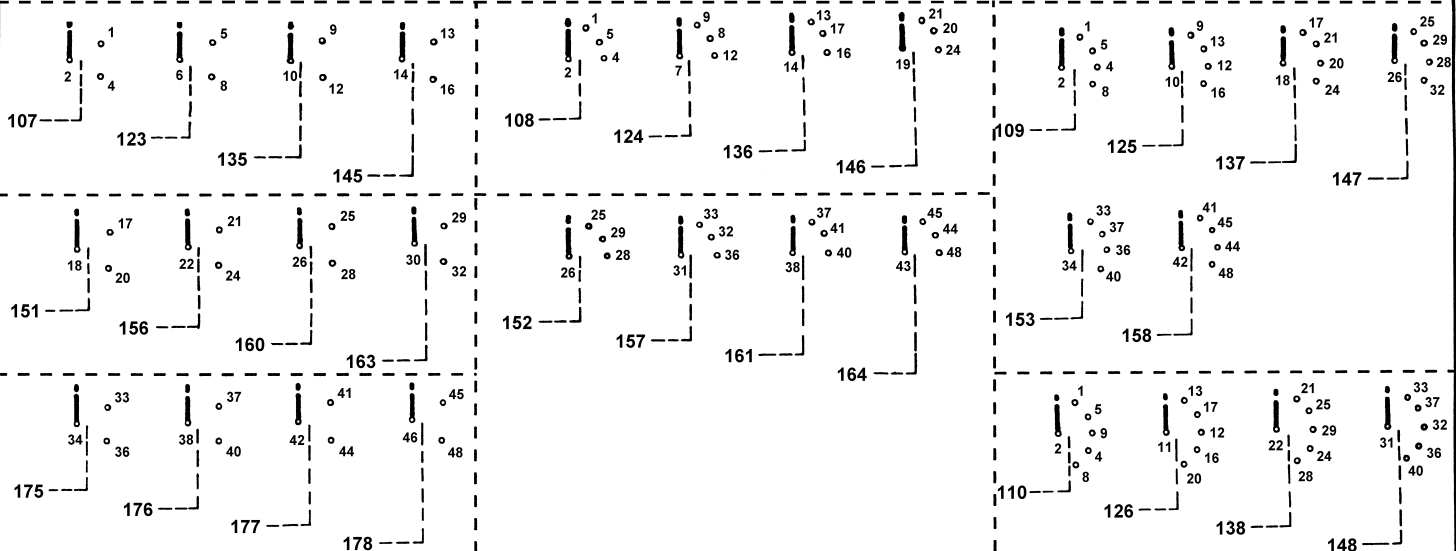

# STEPENASTE SKLOPKE SA "0" POLOŽAJEM / MULTI-STEP SWITCHES WITH "0" POSITION

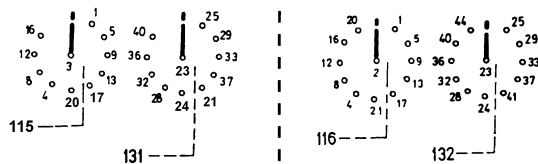
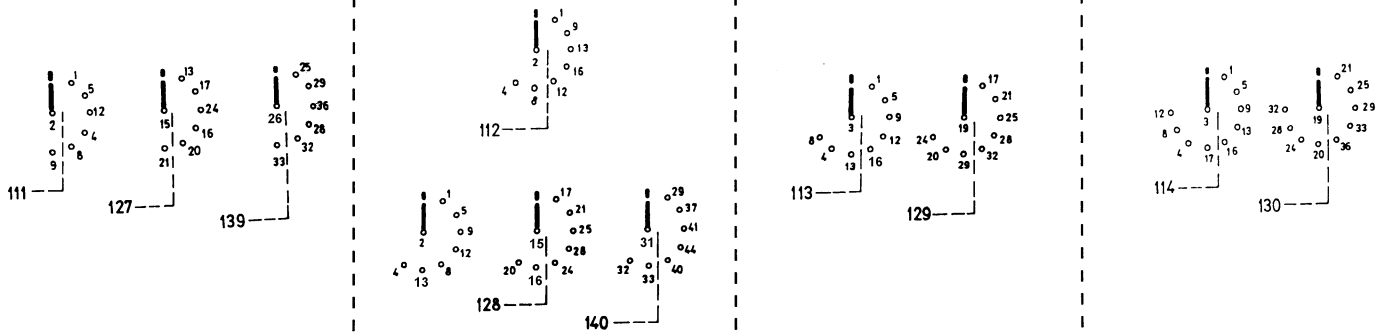

# GRUPNE SKLOPKE / GANG SWITCHES

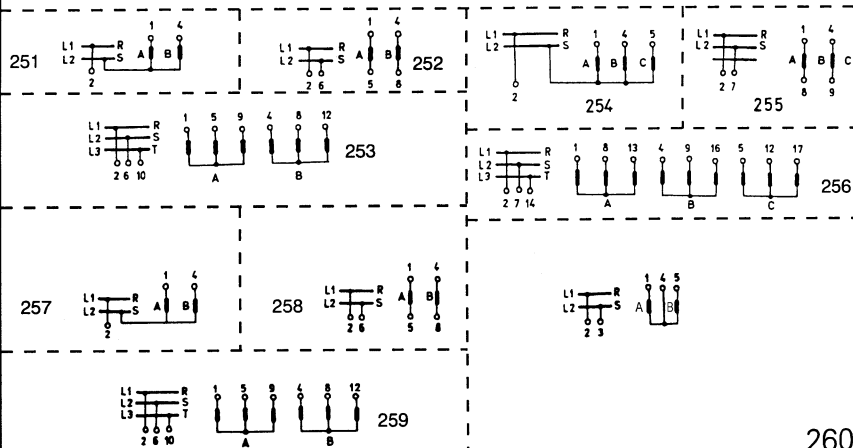

260