

# KONČAR

- Ugradna sklopka
- Front mounting
- Montaža spredaj

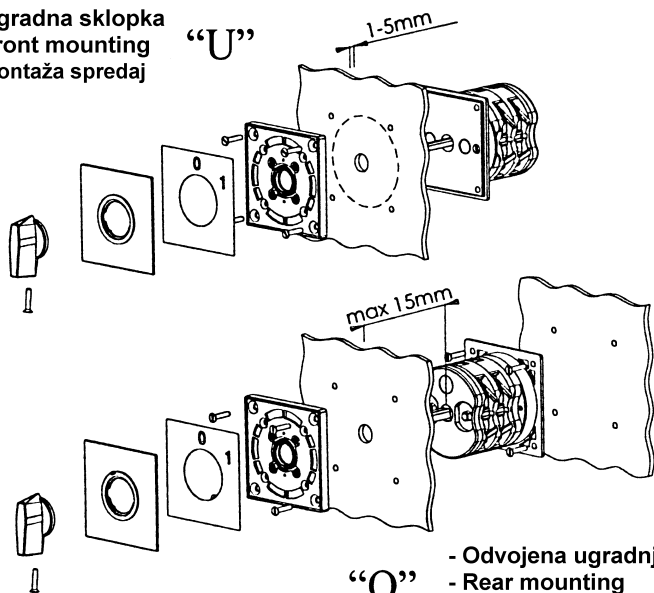

- “O”
- Odvojena ugradnja
  - Rear mounting
  - Montaža zadaj

- Ugradnja u kućište
- Casing mounting
- Montaža v ohišju

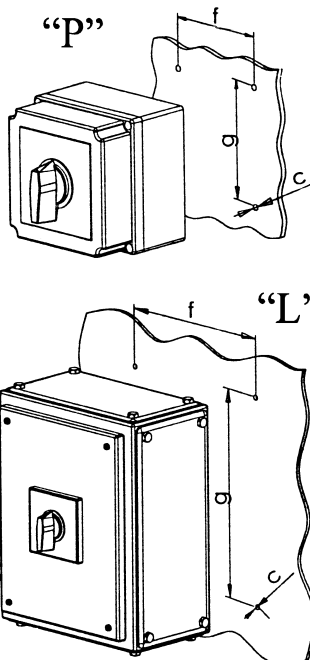

Kućišta Casings Ohišje	Sklopke Switches Stikala	Broj elem. Število elem. (komor)		Plan bušenja rupa Drilling plan for panel Mere pritrditve in izvrtin		
		Nisko Low Nizko	Visoko High Visoko	f	g	φc
Plastično / Plastic / Plástico	75x75 4G10	1-2	3-4	64	50	4,3
	90x90 4G16 4G25	1-2 1-2	3-4 3-4	63	79	4,5
	120x120 4G40 4G63 4G80	1-2 1-2 1-2	3-4 3-4 3-4	107	91	5,3
Limeno / Steel / Jeklo	250x316 4G100 4G200	1-3	4-6	200	270	9
	316x500	4G400	2 4 6	240	420	9
4G630		3 - 6				

- Sklopke 4G100 - 4G1200 preko 6 elemenata obavezno pričvrstiti s prednje i stražnje strane
- Switches 4G100 - 4G1200 with more than 6 elements must be fixed on the both side ( front and rear )
- Stikala 4G100 - 4G1200 z več kot 6 elementi (komorami) se morajo pritrditi s sprednje in zadnje strani

## PLAN BUŠENJA RUPA - DRILLING PLAN FOR PANEL MERE PRITRDTITVE IN IZVRTIN

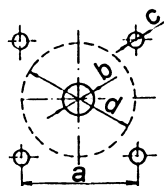

- Za oblik ugradnje
- For mounting form
- Za izvedbo montaže

“U”  
“O”

4G	a	b	c	d
10	□ 36	φ 12	φ 4,3	φ 38
16	48	14	5	60
25				
40				
63	72	14	5,3	80
80				
100 - 1200	104	16	5,3	120

- Skidanje črne ploče
- Removing the transparent plate
- Demontaža čelne plošče

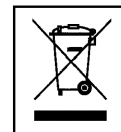
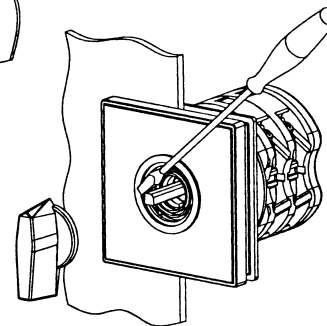

AMPERMETARSKE SKLOPKE / AMMETER SWITCHES / STIKALA ZA PREKLOP AMPERMETRA

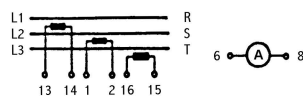

58

( ) 4G10, 4G16, 4G25  
4G10H, 4G16H, 4G25H

97

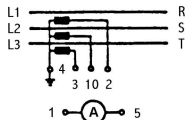

98

VOLTMETARSKO - AMPERMETARSKE SKLOPKE / VOLTMETER - AMMETER SWITCHES / STIKALA ZA PREKLOP VOLTMETRA - AMPERMETRA

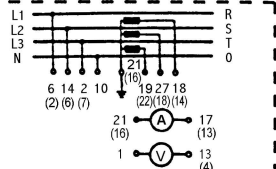

( ) 4G10, 4G16, 4G25  
4G10H, 4G16H, 4G25H

61

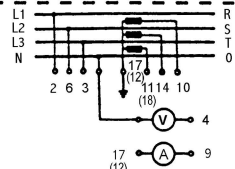

( ) 4G10, 4G16, 4G25  
4G10H, 4G16H, 4G25H

64

VOLTMETARSKE SKLOPKE / VOLTMETER SWITCHES / STIKALA ZA PREKLOP VOLTMETRA

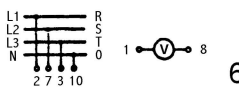

60

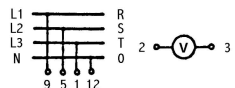

66

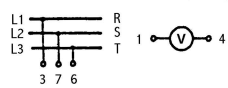

67

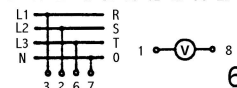

68

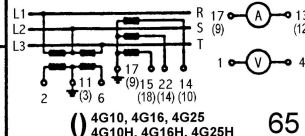

( ) 4G10, 4G16, 4G25  
4G10H, 4G16H, 4G25H

65

SKLOPKE SA POVRATOM - KUT ZAKRETA 30° / SWITCHES SPRING RETURN WITH 30° SWITCHING / AVTOMATSKO VRAČANJE V POLOŽAJ - STIKALNI KOT 30°

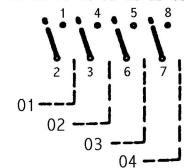

01

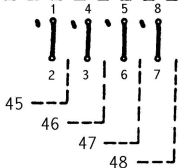

45

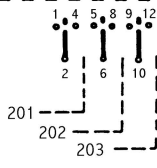

201

SKLOPKE ZA POKRETANJE JEDNOFAZNIH MOTORA / START AND RUN SWITCHES / STIKALA ZA VKLAPLJANJE ENOFAZNIH MOTORJEV

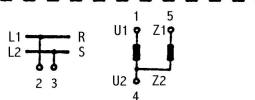

15

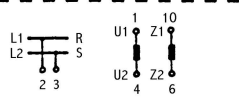

16

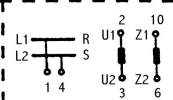

17

UPRAVLJAČKE SKLOPKE SA POVRATOM / CONTROL SWITCHES (WITH SPRING RETURN) / STIKALA Z AVTOMATSKIM VRAČANJEM V POLOŽAJ

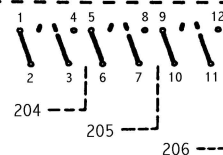

204



207

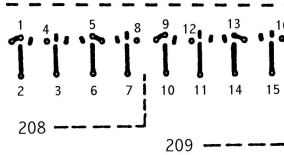

208

209

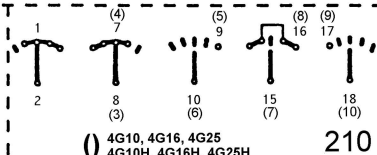

( ) 4G10, 4G16, 4G25  
4G10H, 4G16H, 4G25H

210

MOTORSKE REVERZIONNE SKLOPKE / MOTOR REVERSING SWITCHES / STIKALA ZA VKLAPLJANJE MOTORJEV - DVE SMERI VRTENJA

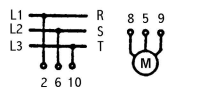

11

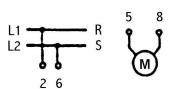

14

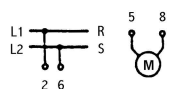

24

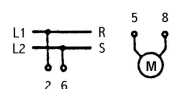

25

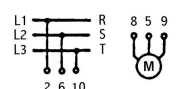

26

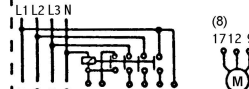

27

( ) 4G10, 4G16, 4G25  
4G10H, 4G16H, 4G25H

ZVIJEZDA - TROKUT SKLOPKE / STAR - DELTA SWITCHES / STIKALA ZA PREKLOP ZVEZDA - TRIKOT

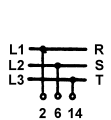

12

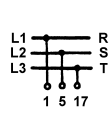

21

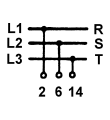

28

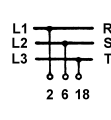

29

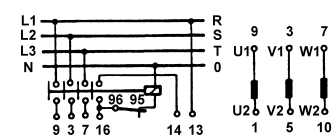

31

SKLOPKE ZA UPRAVLJANJE MOTORIMA (ODVOJENI NAMOTI) / MOTOR CONTROL SWITCHES (SEPARATE WINDINGS) / STIKALA ZA VKLAPLJANJE MOTORJEV (LOČENA NAVITJA)

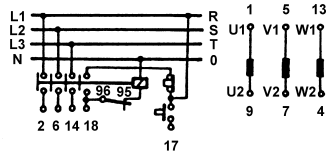

49

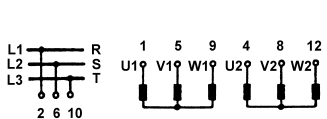

22

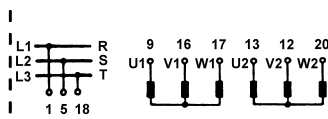

23

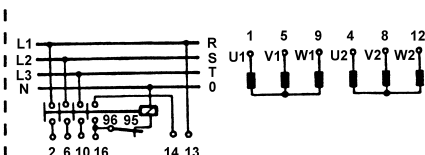

33

SKLOPKE ZA UPRAVLJANJE MOTORIMA (DAHLANDER) / MOTOR CONTROL SWITCHES (DAHLANDER) / STIKALA ZA VKLAPLJANJE MOTORJEV (DAHLANDER)

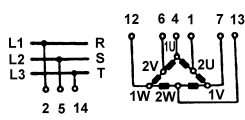

13

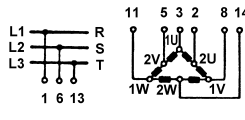

19

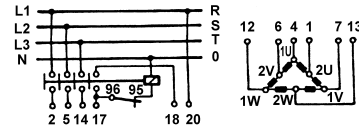

32

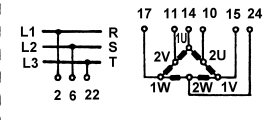

20

SKLOPKE ZA UPRAVLJANJE TROBRZINSKIM MOTORIMA / SWITCHES FOR 3-SPEED MOTOR CONTROL / STIKALA ZA VKLAPLJANJE MOTORJEV - TRI HITROSTI

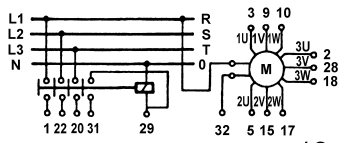

18

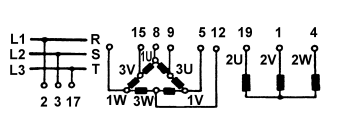

34

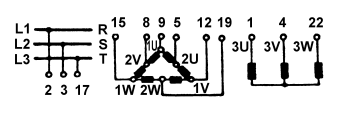

35

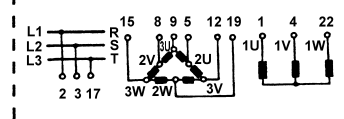

36

SKLOPKE SA KUTEM ZAKRETA 60°  
SWITCHES WITH 60° SWITCHING  
STIKALA S STIKALNIM KOTOM 60°

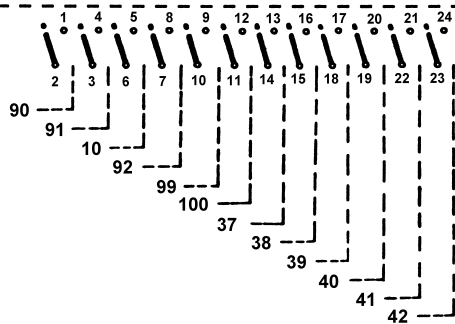

PREKLOPKE SA "0" POLOŽAJEM SA KUTEM ZAKRETA 60°  
CHANGEOVER SWITCHES WITH "0" 60° SWITCHING  
PREKLOPNA STIKALA S POLOŽAJEM "0" IN STIKALNIM KOTOM 60°

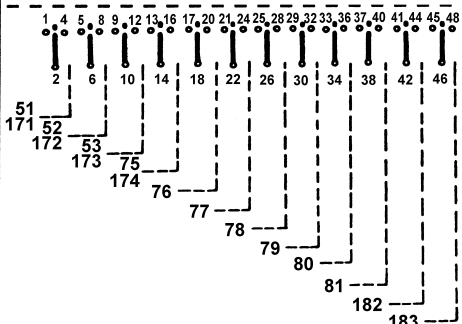

PREKLOPKE BEZ "0" POLOŽAJA SA KUTEM ZAKRETA 90°  
CHANGEOVER SWITCHES WITHOUT "0" 90° SWITCHING  
PREKLOPNA STIKALA BREZ POLOŽAJA "0" IN STIKALNIM KOTOM 90°

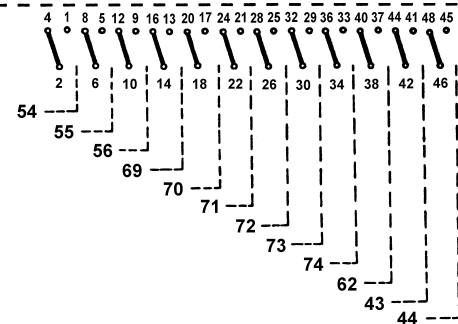

SKLOPKE SA KUTOM ZAKRETA 90° / SWITCHES WITH 90° SWITCHING / STIKALA S STIKALNIM KOTOM 90°

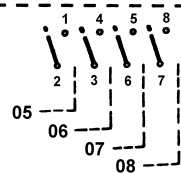

09

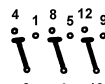

57

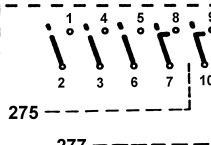

275

277

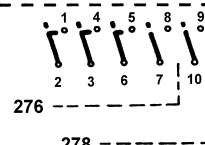

276

278

STEPENASTE SKLOPKE BEZ "0" POLOŽAJA / MULTI-STEP SWITCHES WITHOUT "0" / STOPENJSKA STIKALA BREZ POLOŽAJA "0"

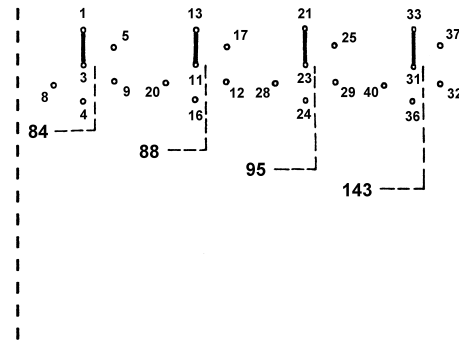
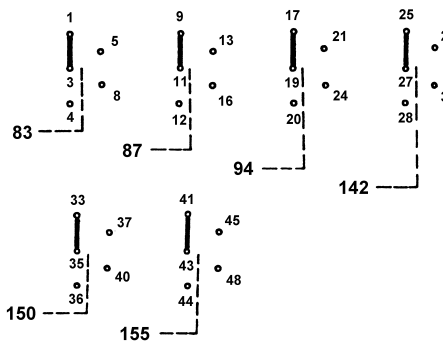
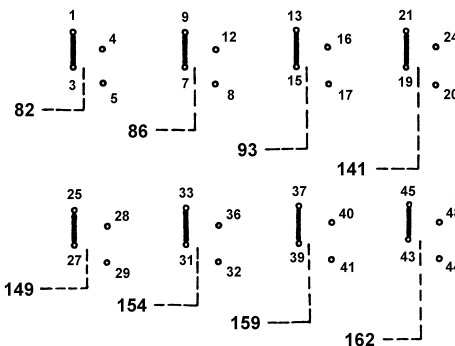

STEPENASTE SKLOPKE BEZ "0" POLOŽAJA / MULTI-STEP SWITCHES WITHOUT "0" / STOPENJSKA STIKALA BREZ POLOŽAJA "0"

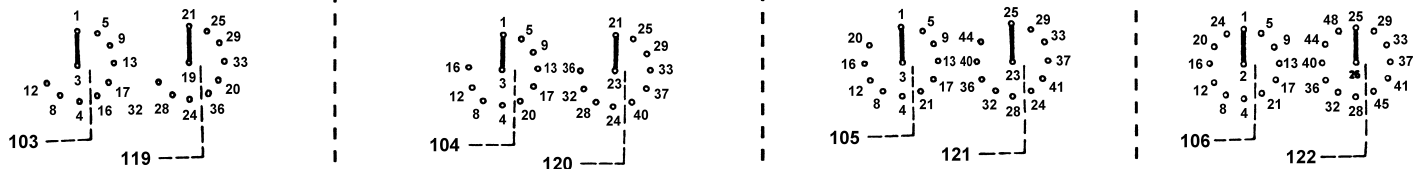
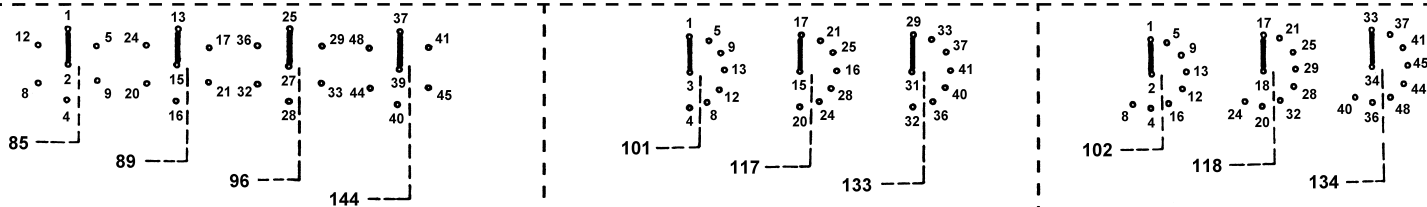

STEPENASTE SKLOPKE SA "0" POLOŽAJEM / MULTI-STEP SWITCHES WITH "0" / STOPENJSKA STIKALA S POLOŽAJEM "0"

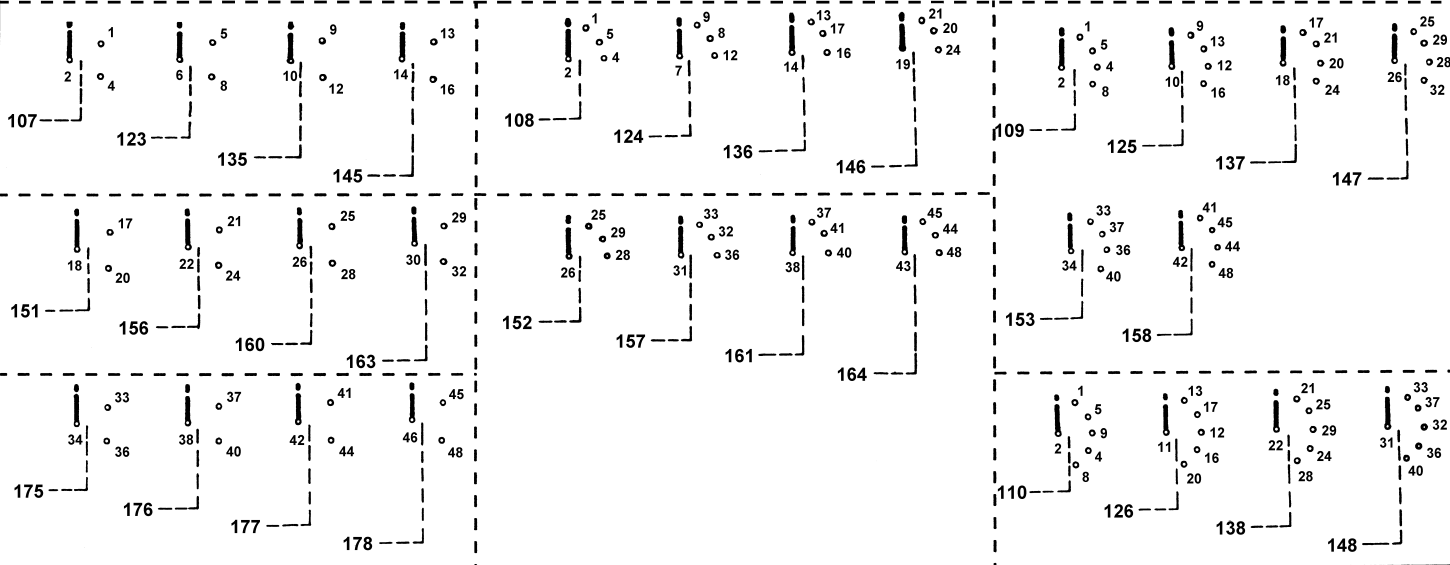

STEPENASTE SKLOPKE SA "0" POLOŽAJEM / MULTI-STEP SWITCHES WITH "0" / STOPENJSKA STIKALA S POLOŽAJEM "0"

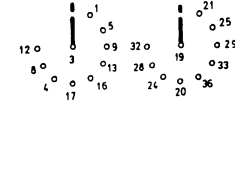
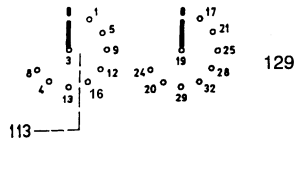
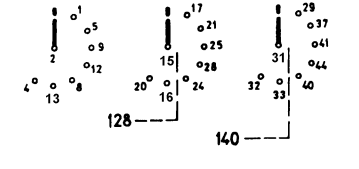
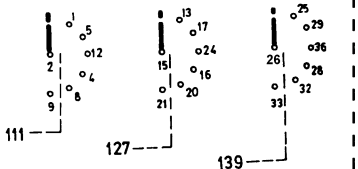
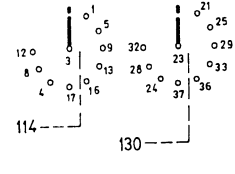
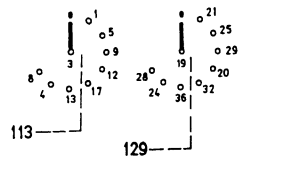
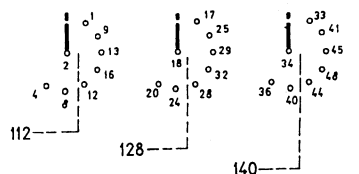
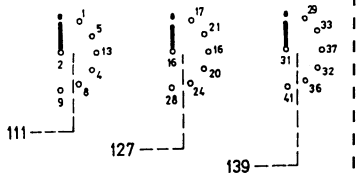

4G10, 4G16, 4G25  
4G10H, 4G16H, 4G25H

4G10, 4G16, 4G25  
4G10H, 4G16H, 4G25H

4G10, 4G16, 4G25  
4G10H, 4G16H, 4G25H

4G10, 4G16, 4G25  
4G10H, 4G16H, 4G25H

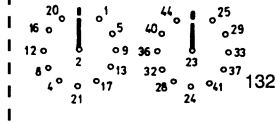
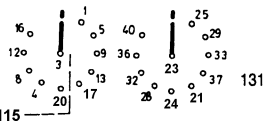
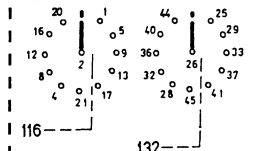
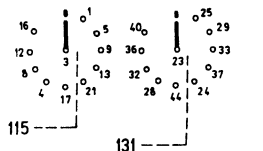

4G10, 4G16, 4G25  
4G10H, 4G16H, 4G25H

4G10, 4G16, 4G25  
4G10H, 4G16H, 4G25H

GRUPNE SKLOPKE / GANG SWITCHES / STIKALA ZA SKUPINSKO PREKLAPLJANJE

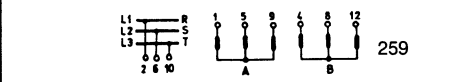
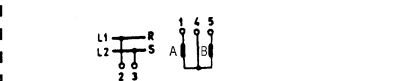
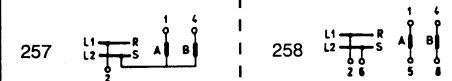
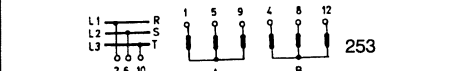
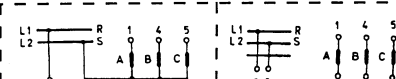
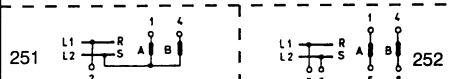

260