

# KOMPAKTNE SKLOPKE za fotonaponske sustave

## SWITCH-DISCONNECTORS for photovoltaic application

# CSP

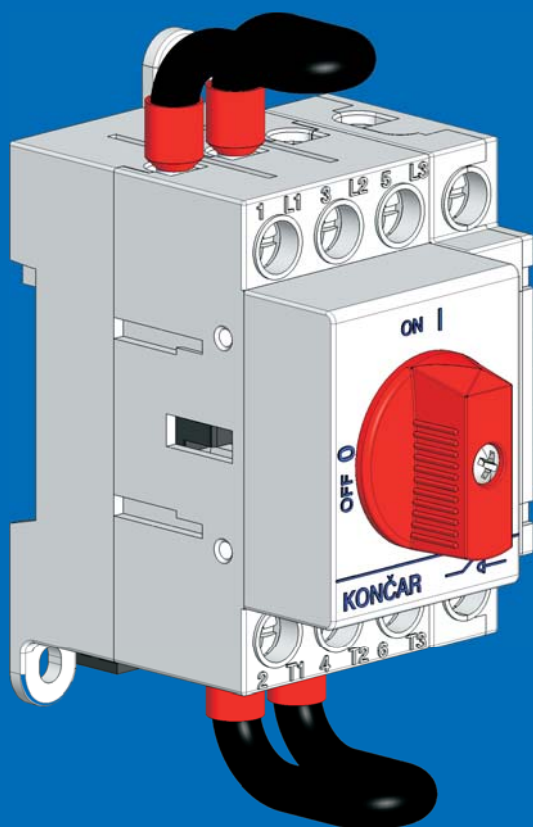

**-DC-**  
**KOMPAKTNA SKLOPKA**  
**SWITCH-DISCONNECTOR**  
**CSP**

**FOTONAPONSKI**  
**MODUL**  
**PHOTOVOLTAIC**  
**MODULE**

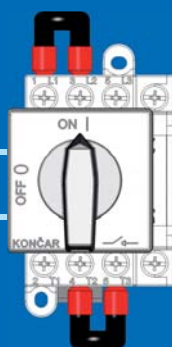

**DC / AC**  
**PRETVARAČ**  
**INVERTER**

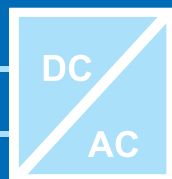

**-AC-**  
**RASTAVNA SKLOPKA**  
**SWITCH-DISCONNECTOR**

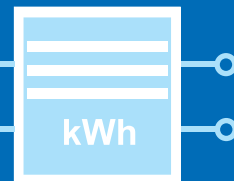
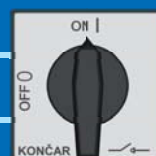

74049



# KONČAR

Razvoj obnovljivih izvora energije na osnovi fotonaponskih panela ima za posljedicu razvoj rastavnih sklopki koje služe za isklapanje istosmjernih strujnih krugova.

Prema normi IEC 60364-7-712 za fotonaponske instalacije mora se osigurati izoliranje, što sklopke serije CSP, s dvostrukim prekidnim mjestom, u potpunosti zadovoljavaju.

S nazivnim pogonskim strujama do 80A u kategoriji upotrebe DC21B, te nazivnim pogonskim naponom do 1000V, ovaj tip sklopki može ispuniti sve zahtjeve instalacija.

Rastavne sklopke su konstruirane tako da se mogu postaviti između fotonaponskih ćelija i DC/AC pretvarača.

The development of renewable energy sources on the basis of photovoltaic panels has resulted with the development of switch-disconnectors which are used for switching off DC circuits.

Switch-disconnectors series CSP with double breaking system completely fulfil requirements for isolation according to IEC 60364-7-712 for photovoltaic installations.

CSP type of switch-disconnectors can meet all requirements of installation with rated operational voltage up to 1000V and operational currents up to 80A in utilization category DC21B.

Switch-disconnectors are designed to be placed between photovoltaic cells and DC/AC inverter.

- Kompaktna konstrukcija
- U skladu s normom IEC 60947
- Stupanj mehaničke zaštite IP65
- Montaža na DIN šinu ili pomoću vijaka

- Compact design
- According to IEC 60947
- Protection degree IP65
- DIN-rail or screw mounting

## SHEME SPAJANJA / CONNECTION DIAGRAMS

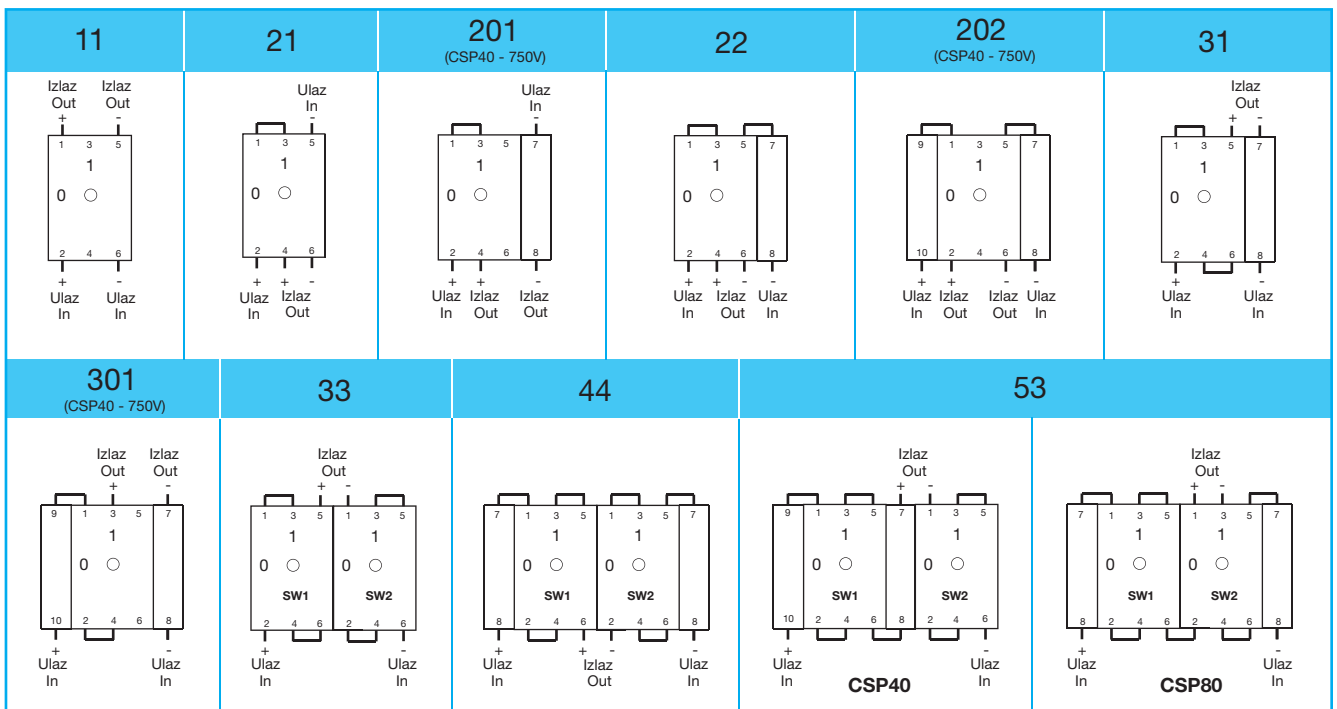

## UGRADNJA POMOĆNIH KONTAKATA / INSTALLING AUXILIARY CONTACTS

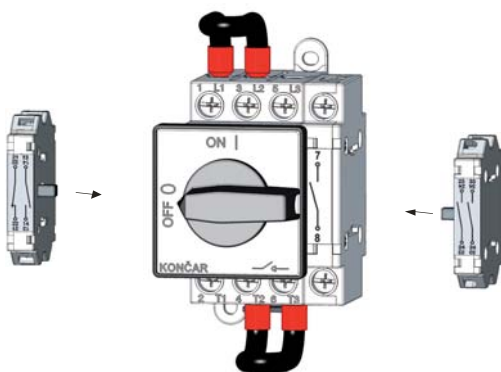

Pomoćni kontakti / Auxiliary contacts

- 1n/o+1n/c
- 2n/o

Prigradnje se montiraju u položaju "0".

Accessories must be mounted in position "0".

## TEHNIČKI PODACI / TECHNICAL DATA

Nazivni pogonski napon Rated operational voltage $U_e$ [V]	Nazivna pogonska struja Rated operational current $I_e$ [A] DC21B	Tip kompaktne sklopke Type of switch-disconnector	Broj polova Number of poles
220	40	CSP40-21	3
	50	CSP80-21	3
	80	CSP80-31 ili/or CSP80-22	4
450	7	CSP40-11	2
	16	CSP40-21	3
	30	CSP40-31 ili/or CSP40-22	4
	40	CSP40-33	6
	40	CSP40-44	8
	63	CSP80-31 ili/or CSP80-22	4
	80	CSP80-33	6
	80	CSP80-44	8
500	16	CSP40-21	3
	30	CSP40-31 ili/or CSP40-22	4
	35	CSP80-31 ili/or CSP80-22	4
	35	CSP40-33	6
	40	CSP40-44 ili/or CSP40-53	8
	50	CSP80-33	6
	80	CSP80-44 ili/or CSP80-53	8
600	12	CSP40-21	3
	18	CSP40-31 ili/or CSP40-22	4
	45	CSP80-33	6
	65	CSP80-53 ili/or CSP80-44	8
750	8	CSP40-201	3
	12	CSP40-301 ili/or CSP40-202	4
	35	CSP40-33	6
	40	CSP40-44 ili/or CSP40-53	8
	45	CSP80-33	6
	50	CSP80-44 ili/or CSP80-53	8
1000	16	CSP40-33	6
	20	CSP40-44 ili/or CSP40-53	8
	20	CSP80-33	6
	30	CSP80-44 ili/or CSP80-53	8

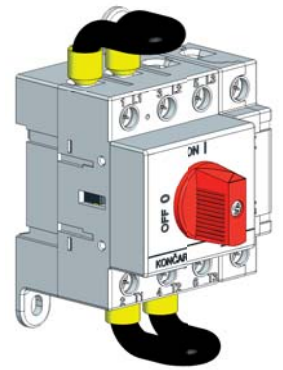

CSP80-31-40048D



CSP40-31-O48D,56

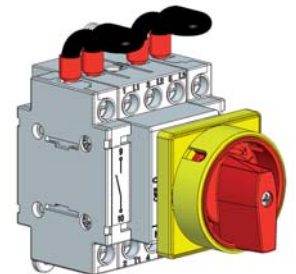

CSP40-202-40006

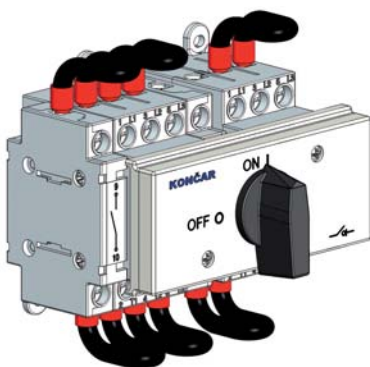



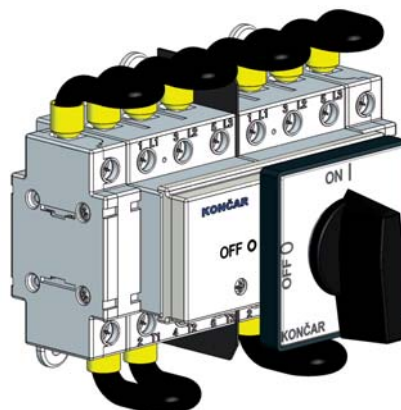



CSP40-53-O48D



CSP80-44-O



# STANDARDNE I POSEBNE IZVEDBE / STANDARD DESIGNS AND OPTIONAL EXTRAS

NAZIV / NAME		IZGLED / FORM	KOD / CODE				OPIS / DESCRIPTION		
			1	2	3	4			
STANDARDNE SKLOPKE / STANDARD SWITCHES	SKLOPKA ZA ODVOJENU UGRADNJU REAR MOUNTING		CSP40	-	...	-	O	Standardna sklopka za odvojenu ugradnju - prednji sklop □48 / Standard rear mounting - front assembly □48	
			CSP80	-	...	-	O	Standardna sklopka za odvojenu ugradnju - prednji sklop □65 / Standard rear mounting - front assembly □65	
	SKLOPKA U PLASTIČNOM KUČIŠTU SWITCH IN PLASTIC CASING		CSP40	-	...	-	P	Standardna sklopka u plastičnom kućištu – veličinu plastičnog kućišta za pojedinu sklopku vidi u tablici na strani 6 (standardno se isporučuje s navojem za Pg ulovnice) / Standard switch in plastic casing – dimension of plastic casing see in the table on page 6 (standard with Pg conduit entries)	
	INSTALACIONA KAPA SERVICE COVER		CSP40	-	...	-	O	48D	Montaža na šinu 35 EN 50022 s instalacionom kapom za ugradnju u standardni otvor 45mm / Snap on base mounting for the rail 35 EN 50022 for 45mm standard knock-out
			CSP80	-	...	-	O	48D	
	SKLOPKA SA ZAKLJUČAVANJEM LOKOTOM SWITCH WITH PADLOCK		CSP40	-	...	-	O	06	Ručica, česna ploča i prednja ploča sive boje / The grey colour of the handle, cover plate and front plate
			CSP80	-	...	-	O	06	
	SKLOPKA SA ZAKLJUČAVANJEM LOKOTOM SWITCH WITH PADLOCK		CSP40	-	...	-	O	56	Ručica i prednja ploča crne, a podloga sive boje / Black handle and front plate, grey escutch. plate
			CSP80	-	...	-	O	56	
	INSTALACIONA KAPA SA ZAKLJUČAVANJEM LOKOTOM SERVICE COVER WITH PADLOCK		CSP40	-	...	-	O	48D, 56	Montaža na šinu 35 EN 50022 s instalacionom kapom za ugradnju u standardni otvor 45mm / Snap on base mounting for the rail 35 EN 50022 for 45mm standard knock-out
			CSP80	-	...	-	O	48D, 56	



RUČICA HANDLE	Y KOD / CODE
crna/black	
crvena/red	40

RUČICA HANDLE	ČESNA PLOČA COVER PLATE	PREDNJA PLOČA FRONT PLATE	Y KOD / CODE
siva/grey	siva/grey	siva/grey	
crna/black	crna/black	crna/black	20
crvena/red	žuta/yellow	žuta/yellow	40

RUČICA HANDLE	PREDNJA PLOČA FRONT PLATE	PODLOGA ESCUT. PLATE	Y KOD / CODE
crna/black	crna/black	siva/grey	
crna/black	crna/black	crna/black	20
siva/grey	siva/grey	siva/grey	30
crveno žuta/ red yellow	žuta/yellow	žuta/yellow	40

RUČICA HANDLE	Y KOD / CODE
crna/black	
siva/grey	30
crveno žuta/ red yellow	40

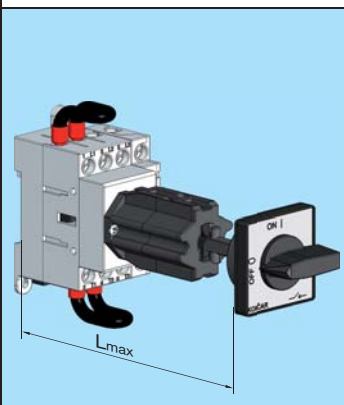
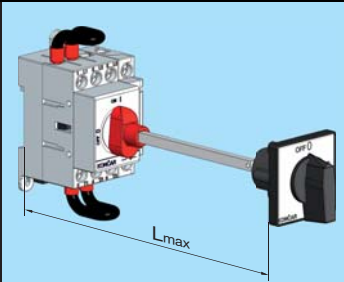
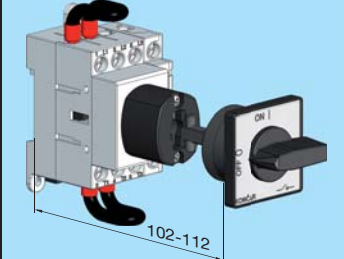
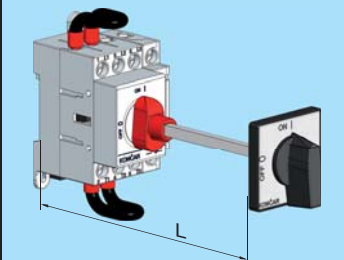
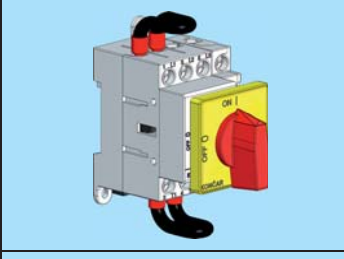
## POSEBNE IZVEDBE / OPTIONAL EXTRAS

NAZIV / NAME	IZGLLED / FORM	KOD / CODE				OPIS / DESCRIPTION																	
		1	2	3	4																		
SPOJKA ZA VRATA / DOOR COUPLING	 <p>SPOJKA ZA VRATA I PRODUŽENJE OSOVINE MODULIMA DOOR COUPLING AND MODULE SHAFT EXTENSION</p>	CSP40	-	...	-	O	108D	<p>Omogućena je prilagodba različitim dubinama ugradnje. Otvaranje vrata u položaju «0». Standardno se isporučuje s jednim modulom / Used to adapt switches to different mounting depths. Door opening in position «0». Standard version with one module</p> <table border="1"> <thead> <tr> <th>Kod / Code</th> <th>Izvedba / version</th> <th>Lmax</th> </tr> </thead> <tbody> <tr> <td>108D</td> <td>Standardna izvedba s jednim modulom Standard version with one module</td> <td>120</td> </tr> <tr> <td>108D-2</td> <td>Izvedba s dva modula Version with two modules</td> <td>145</td> </tr> <tr> <td>108D-3</td> <td>Izvedba s tri modula Version with three modules</td> <td>170</td> </tr> <tr> <td>108D-4</td> <td>Izvedba s četiri modula Version with four modules</td> <td>195</td> </tr> </tbody> </table>	Kod / Code	Izvedba / version	Lmax	108D	Standardna izvedba s jednim modulom Standard version with one module	120	108D-2	Izvedba s dva modula Version with two modules	145	108D-3	Izvedba s tri modula Version with three modules	170	108D-4	Izvedba s četiri modula Version with four modules	195
		Kod / Code	Izvedba / version	Lmax																			
		108D	Standardna izvedba s jednim modulom Standard version with one module	120																			
		108D-2	Izvedba s dva modula Version with two modules	145																			
108D-3	Izvedba s tri modula Version with three modules	170																					
108D-4	Izvedba s četiri modula Version with four modules	195																					
CSP80	-	...	-	O	108D																		
CSP40	-	...	-	O	102																		
CSP80	-	...	-	O	102																		
SPOJKA ZA VRATA I PRODUŽENJE OSOVINE DOOR COUPLING AND SHAFT EXTENSION	 <p>SPOJKA ZA VRATA I PRODUŽENJE OSOVINE DOOR COUPLING AND SHAFT EXTENSION</p>	CSP40	-	...	-	O	102	<p>Otvaranje vrata u položaju «0». Standardno se isporučuje s osovinom dužine 100 mm / Door opening in position «0». Standard version with 100 mm shaft</p> <table border="1"> <thead> <tr> <th>Kod / Code</th> <th>Izvedba / Version</th> <th>Lmax</th> </tr> </thead> <tbody> <tr> <td>102</td> <td>Osovina 100 mm Shaft 100 mm</td> <td>175 mm</td> </tr> <tr> <td>102-200</td> <td>Osovina 200 mm Shaft 200 mm</td> <td>275 mm</td> </tr> </tbody> </table>	Kod / Code	Izvedba / Version	Lmax	102	Osovina 100 mm Shaft 100 mm	175 mm	102-200	Osovina 200 mm Shaft 200 mm	275 mm						
		Kod / Code	Izvedba / Version	Lmax																			
		102	Osovina 100 mm Shaft 100 mm	175 mm																			
		102-200	Osovina 200 mm Shaft 200 mm	275 mm																			
CSP80	-	...	-	O	102																		
CSP40	-	...	-	O	58D																		
CSP80	-	...	-	O	58D																		
SPOJKA ZA VRATA DOOR COUPLING	 <p>SPOJKA ZA VRATA DOOR COUPLING</p>	CSP40	-	...	-	O	58D	<p>Otvaranje vrata u položaju «0» (izvedba <b>58D</b>) ili u bilo kojem položaju (izvedba <b>57D</b>) / Door opening in position «0» (optional extra <b>58D</b>) or in any position (optional extra <b>57D</b>)</p>															
		CSP80	-	...	-	O	58D																
		CSP40	-	...	-	O	57D																
		CSP80	-	...	-	O	57D																
PRODUŽENA OSOVINA EXTENDED SHAFT	 <p>PRODUŽENA OSOVINA EXTENDED SHAFT</p>	CSP40	-	...	-	O	02	<p>Standardno se isporučuje za kotu „L“ 250 mm. Drugačiju dubinu ormara potrebno je navesti u narudžbi / Standard version for “L” 250 mm. Different board depth is necessary to define</p>															
		CSP80	-	...	-	O	02																
SKLOPKA ZA NUŽNO ISKLAPANJE EMERGENCY OFF SWITCH	 <p>SKLOPKA ZA NUŽNO ISKLAPANJE EMERGENCY OFF SWITCH</p>	CSP40	-	...	-	O	24	<p>Sklopka sa crvenom ručicom, žutom prednjom pločom i žutom podlogom / Switch with red handle, yellow front plate and yellow escutcheon plate</p>															
		CSP80	-	...	-	O	24																
DVOSTRUKO UPRAVLJANJE TANDEM CONTROL	 <p>DVOSTRUKO UPRAVLJANJE TANDEM CONTROL</p>	CSP40	-	...	-	O	154	<p>Izvedba je moguća za sheme 11, 21, 31 i 22 Optional extra is possible for scheme 11, 21, 31 and 22</p>															
		CSP80	-	...	-	O	154																

# MJERNE SKICE / DIMENSIONAL DRAWINGS

ODVOJENA UGRADNJA  
REAR MOUNTING

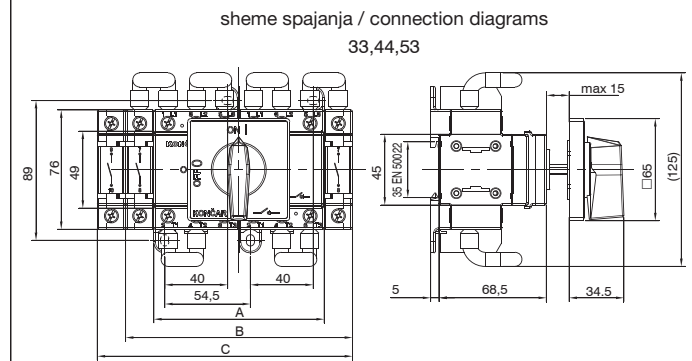
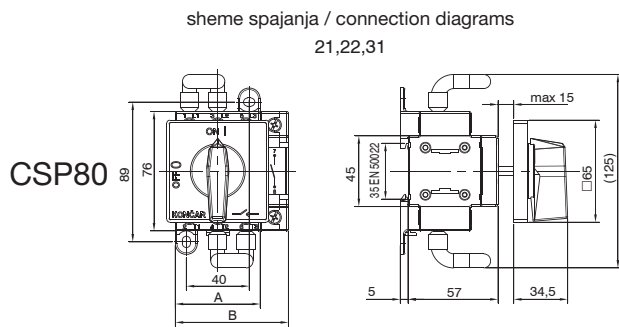
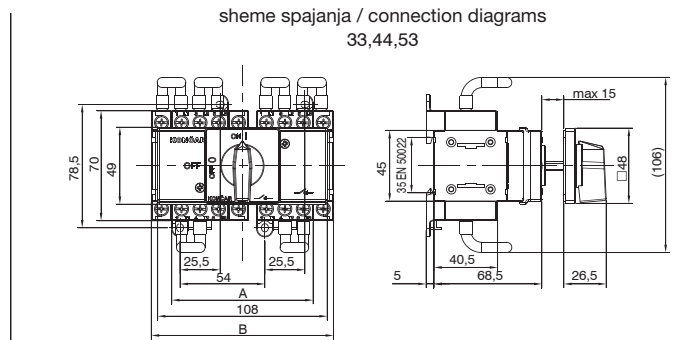
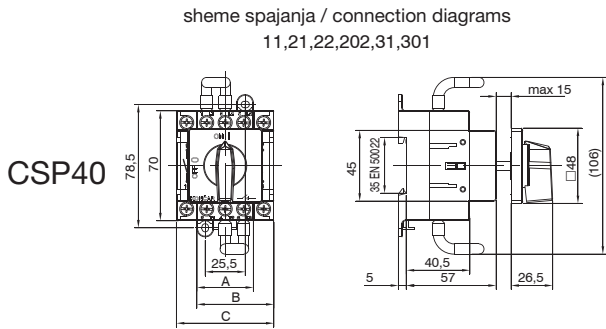

Tip / Type	CSP40					CSP80				
	11,21	22,31	202,301	33	44,53	21	22,31	33	44	53
<b>A</b>	36	-	-	90	-	54	-	108,5	-	-
<b>B</b>	-	49	-	-	116	-	72	-	144,5	-
<b>C</b>	-	-	62	-	-	-	-	-	-	162,5

# PLAN BUŠENJA / DRILLING PLAN

Stražnji lim  
Rear plate

Prednji lim  
Front plate

sheme spajanja / connection diagrams  
11,21,22,202,31,301

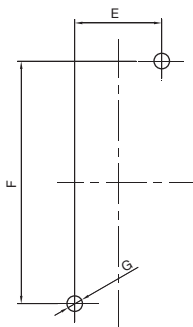

sheme spajanja / connection diagrams  
33,44,53

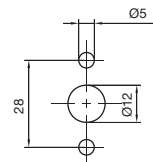
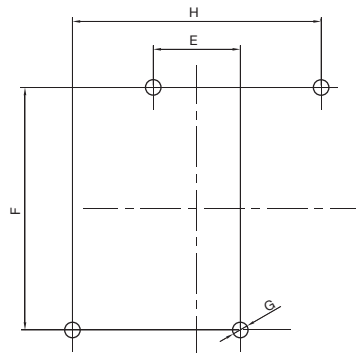

Tip / Type	E	F	G	H	
11,21,22,202,31,301	CSP40	25	78	4,5	-
	CSP80	40	88	5,5	-
33,44,53	CSP40	28	78	4,5	80
	CSP80	14	88	5,5	94



# SKLOPKA U PLASTIČNOM KUĆIŠTU / SWITCH IN PLASTIC CASING

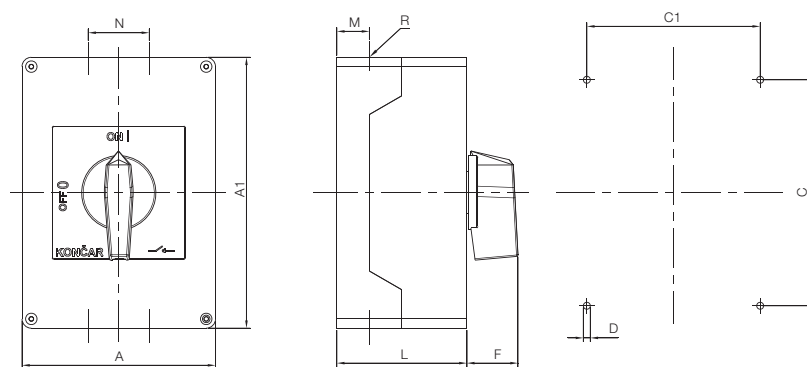

Tip/Type	Tip kućišta Casing size	A	A1	C	C1	D	F	M	N	L	Zaštita Protection	R(Pg)	Uvodnice Conduit entries	R(M...x1,5)	
CSP40-11 CS P40-21 CS P40-201 CS P40-22 CS P40-202 CS P40-31 CS P40-301	CSP 80-21 CSP 80-22 CSP 80-31	125x175	125	175	146	112	5,5	32	21	68	84	IP65	4xPg21+2xPg11	ili / or	4xM25+2xM16
CSP40-33 CSP40-44 CSP40-53	125x175	125	175	146	112	5,5	32	21	68	118	IP65	4xPg21+2xPg11	ili / or	4xM25+2xM16	
CSP80-33	140x210	149	218	111,5	200,5	5,5	32	31,5	69	146,5	IP65	8xPg(16-29)+ 4xPg11	ili / or	8xM(20-32)+ 4xM16	
CSP80-44 CSP80-53	210x210	218	218	200	180	5,5	32	31,5	109	146,5	IP65	12xPg(16-29)	ili / or	12xM(20-32)	

## NARUŽBENI KODOVI PRIGRADNJI / ORDERING CODES FOR ACCESSORIES

### Pomoćni kontakti / Auxiliary contacts

1n/o+1n/c 2n/o



n/o kontakt: kasniji uklop - raniji isklop  
n/o contact: late make - early break

Vrsta pom. kontakata Type of aux. contacts	«O»
1n/o+1n/c	B71732
2n/o	B71734

### Kućište / Casing (IP65)



Tip kućišta Casing size	Pg	M
125x175x84	B71769	B71770
125x175x118	B72152	B72153
140x210x146,5	B72154	-
210x210x146,5	B72155	-

### Osovina za posebnu izvedbu "102" Shaft for optional extra "102"



X(mm)	Narudžbeni kod Ordering code
100	B71840
200	B71841

### Modul za posebnu izvedbu "108" Module for optional extra "108"

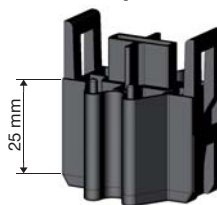

Modul Module	Narudžbeni kod Ordering code
108	B71717

### Mehanizam za dvostruko upravljanje / Mechanism for tandem control



Narudžbeni kod  
Ordering code  
B71764

### Mehanizam preklopke / Mechanism for changeover



Narudžbeni kod  
Ordering code  
B71765

# NARUDŽBENI KOD / ORDERING CODE

Prilikom naručivanja sklopke potrebno je definirati:

- za **standardnu izvedbu** sklopke 3 tipa podataka **1 2 3**
- za sklopke sa **posebnom izvedbom** maksimalno 5 tipova podataka **1 2 3 4 5** ili **1 2 3 4 6**
- za sklopku sa **specijalnim zahtjevima** maksimalno 6 tipova podataka

**1 2 3 4 5 Y** ili **1 2 3 4 6 Y**      **1 2 3 4 5 Y** or **1 2 3 4 6 Y**

When ordering please define:

- for **standard** switch three data types **1 2 3**
- for switch with an **optional extra** max. 5 data types **1 2 3 4 5** or **1 2 3 4 6**
- for switch with a **special request** max. 6 data types

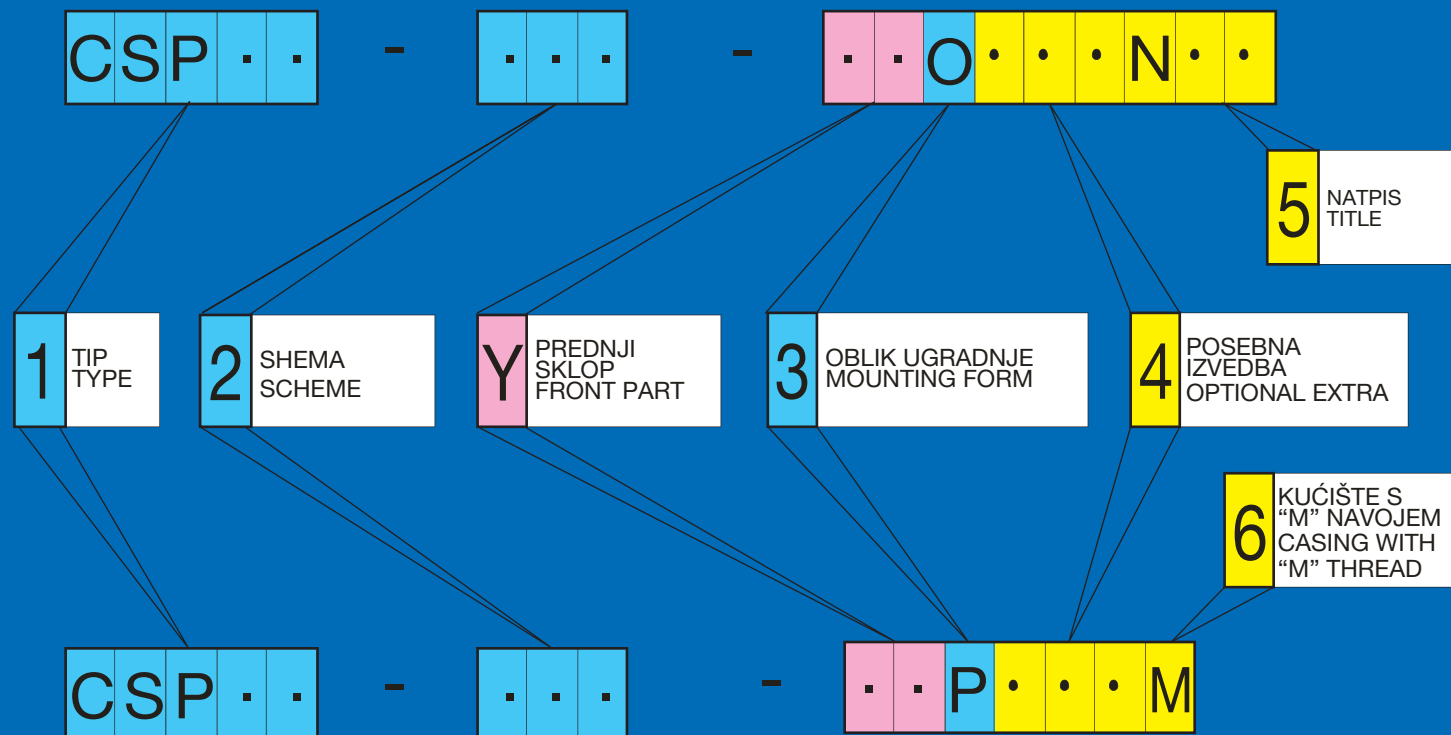

## OPIS

## DESCRIPTION

1	Tip sklopke. Odabire se prema tehničkim zahtjevima (vidi stranu 2)	Switch type. To be chosen in accordance with the technical requests (see page 2)
2	Shema sklopke. Odabire se prema tehničkim zahtjevima i odgovarajućem načinu ožičavanja	Switching diagram. To be chosen in accordance with the technical requests and type of wiring
Y	Prednji sklop. Upisuje se samo ako se traži nestandardna kombinacija boja i oblika prednjeg sklopa. Kod standardne izvedbe - ručica, prednja ploča i slova na sivoj podlozi su crni	Front part. To be marked only when non-standard front part colour and form combination is required. For standard form - handle, front plate and text on the grey escutcheon plate are black
3	Standardni oblici ugradnje O - Odvojena ugradnja P - Plastično kućište	Standard mounting forms O - Rear mounting P - Plastic casing
4	Upisuje se ako se traži posebna izvedba (vidi str. 3 - 4)	To be marked when an optional extra is required (see pages 3 - 4)
5	"N" se upisuje ako se traži prednja ploča s natpisom	"N" is to be written when the front plate with a title is required
6	Upisuje se "M" ako se želi kućište s metričkim navojem. Standardna izvedba s navojem za Pg ulovnice	"M" is to be written when casing with metric thread is required. Standard version with Pg conduit entries

Pridržavamo pravo promjene podataka. Ostale podatke dajemo na upit.  
We keep the right to change the data. Other data are given on request.

# KONČAR

NISKONAPONSKE SKLOPKE I PREKIDAČI d.o.o.

10002 ZAGREB, Borongajska cesta 81b  
Tel.: +385 (0)1/2369 201, 2337 011; Fax.: +385 (0)1/2395 659  
Tel.: +385 (0)1/2369 243, 2318 115; Fax.: +385 (0)1/2318 918  
E-mail: prodaja@koncar-nsp.hr, export@koncar-nsp.hr  
www.koncar-nsp.hr